



CRETA TOP DORMITORIOS



**CRETA
TOP**
V.5

HOME

ROOM

LIFE

LOOK

360

GRUPO EXOJO / DORMITORIOS

ALWAYS REMAIN AUTHENTIC

CRETA TOP V.5

A VECES LA FELICIDAD ES UNA SENSACIÓN.
OTRAS VECES ES UNA DECISIÓN.
SOMETIMES HAPPINESS IS A FEELING. SOMETIMES
IT'S A DECISION.
PARFOIS, LE BONHEUR EST UNE SENSATION.
L'AUTRE FOIS EST UNE DECISION.



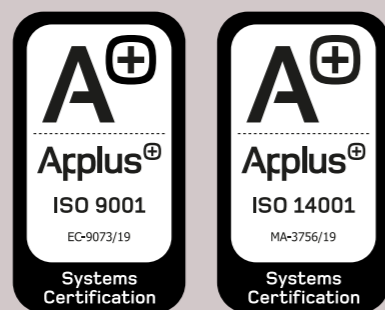

C

SUPERB

Я

EXCELLENT

E

NOTORIOUS

T

DESIGN

A

INSPIRING

TOP

SENSITIVE

A DIFFERENT



COMFORT ZONE

EL NUEVO CRETA TOP ES COMPLETAMENTE DIFERENTE, ES UN CATÁLOGO EN EL QUE LA ESTANCIA MÁS PERSONAL DE LA CASA COBRA OTRO SENTIDO. UN ESPACIO QUE PODRÁS DISEÑAR A TU GUSTO GRACIAS A LAS DISTINTAS CONFIGURACIONES DE CABECEROS, LOS NUMEROSOS MODELOS DE MESITAS, BAÑERAS, CANAPÉS, ARMARIOS CON INFINIDAD DE COMPLEMENTOS PARA HACER SU INTERIOR SEGÚN TUS NECESIDADES... TODO ELLO CON UNOS ACABADOS ACORDES CON LAS ÚLTIMAS TENDENCIAS.

THE NEW CRETA TOP IS COMPLETELY DIFFERENT, IT IS A CATALOGUE IN WHICH THE MOST PERSONAL ROOM OF THE HOUSE TAKES ON A DIFFERENT MEANING. A SPACE THAT YOU WILL BE ABLE TO DESIGN JUST THE WAY YOU LIKE IT, THANKS TO WIDE RANGE OF HEADBOARDS THE NUMEROUS MODELS OF BEDSIDES, BED BASES, OTTOMAN BEDS, WARDROBES WITH INFINITY OF COMPLEMENTS TO MAKE THE INSIDE ACCORDING TO YOUR NEEDS... ALL THIS WITH FINISHES IN ACCORDANCE WITH THE LATEST TRENDS.

LE NOUVEAU CRETA TOP EST COMPLÈTEMENT DIFFÉRENT, C'EST UN CATALOGUE DANS LEQUEL LE SÉJOUR LE PLUS PERSONNEL DE LA MAISON PREND UN AUTRE SENS. UN ESPACE QUE VOUS POURREZ CRÉER À VOTRE GOÛT AVEC LES DIFFÉRENTES CONFIGURATIONS DE TÊTES DE LIT, LES NOMBREUX MODÈLES DE TABLES DE NUIT, CADRES DE LIT, LITS COFFRE, ARMOIRES AVEC INFINITÉ DE COMPLÉMENTS POUR PERSONNALISER L'INTÉRIEUR SELON VOS BESOINS... TOUT CELA AVEC DES FINITIONS EN ACCORD AVEC LES DERNIÈRES TENDANCES.

La perfecta fusión entre las líneas rectas inclinadas y las terminaciones redondeadas han dado lugar a AXIOS. Un cabecero que genera un punto focal en la estancia gracias a una elegancia actual acentuada por la iluminación led que lleva incluida.

The perfect fusion between leaning straight lines and rounded ends have given rise to AXIOS. A xl headboard that generates a focal point in the room thanks to a current elegance marked by the led lighting included.

La fusion parfaite de lignes droites inclinées et de formes arrondies ont donné comme résultat AXIOS. Une tête de lit xl qui génère un point focal dans la pièce grâce à une élégance actuelle accentuée par l'éclairage led inclus.

AXIOS 01

NATURALE - BLANCO NORDIC
cabecero AXIOS - bañera TIPO "E" -
mesita INO - sinfonier INO

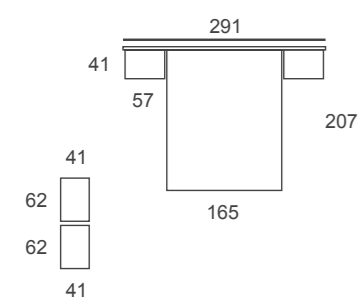

AXIOS 02

La mesita Lux 2+1 es perfecta para guardar pequeños objetos cotidianos y siempre tenerlos a mano todo ello sin perder la funcionalidad del resto de cajones. Cuenta con interior en acabado efecto cuero y guías ocultas con cierre amortiguado. En la imagen también podemos observar el detalle de la elegante terminación del cabecero AXIOS.

The Lux 2+1 bedside is perfect for storing small objects and always have them at hand without losing the functionality of other drawers. Inside in leather effect finished and runner slides with soft closing. In the picture you can also observe in detail the elegant finish of the headboard xl AXIOS.

La table de nuit Lux 2+1 est parfaite pour ranger les petits objets de la vie quotidienne et les avoir toujours à la main sans perdre la fonctionnalité des autres tiroirs. Il a un intérieur effet cuir et des coulisses cachées avec une fermeture amortie. Sur l'image, on peut aussi voir en détail la finition élégante de la tête de lit xl AXIOS.



INTERIOR
EFECTO CUERO 
Inside in leather effect
Intérieur effet cuir

SHAMAL - STONE ROCK
cabecero AXIOS - canapé elevable FORMA -
mesita LUX

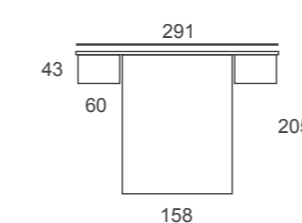

AXIOS 03

AXIOS N 03

Detalle de la nueva pata home con un diseño muy actual en ABS color grafito. Descubre más detalles de este ambiente en una vista completamente diferente leyendo el código QR.

Detail of the new legs home with an actual design in ABS color grafito. Discover more details of this scene in a completely different view by reading the code QR.

Détail du nouveau pied home avec un design très actuel en ABS couleur grafito. Découvrez plus de détails sur cet espace dans une vue complètement différente en lisant le code QR.



IRON - BOCAMINA
cabecero AXIOS - bañera TIPO "P" -
mesita INO - sinfonier INO - patas HOME

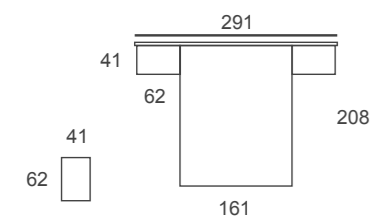



TESALIA 04

TESALIA N 04

Los acabados redondeados cobran protagonismo en la estancia gracias al nuevo cabezal TESALIA, los auxiliares de la serie INO y al canapé elevable forma. Todo ello en grosores de 30mm.

The rounded finishes gains special prominence in the room thanks to the new TESALIA xl headboard, the storage units of the INO series and the shaped ottoman bed. All items in thickness 30mm.

Les finitions arrondies occupent le centre de l'espace grâce à la nouvelle tête de lit xl TESALIA, les auxiliaires de la série INO et le lit coffre forma. Tout cela dans une épaisseur de 30mm.

NUDE - BOCAMINA
cabeceo TESALIA - canapé elevable FORMA -
mesita INO - sinfonier INO

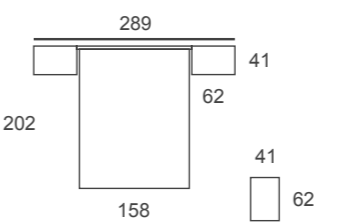
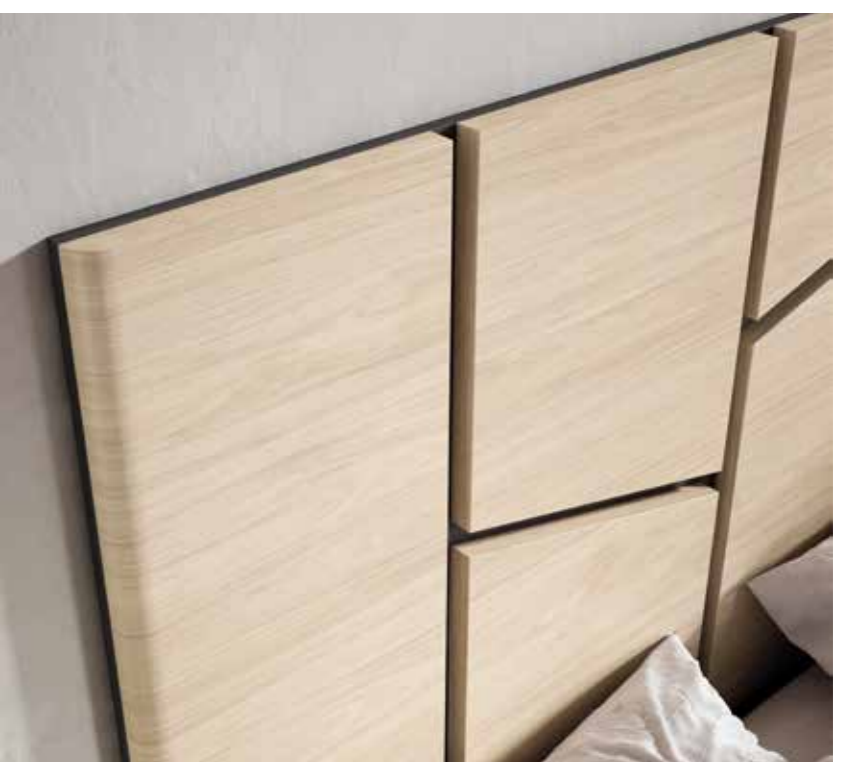

FONDO EFECTO CUERO 
Bottom in leather effect
Fond en effet cuir



05B SHAMAL - STONE ROCK

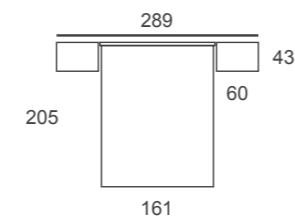

TESALIA 05

NATURALE - STONE ROCK
cabecero TESALIA - bañera TIPO "P" -
mesita LUX

A VECES LA FELICIDAD ES UNA SENSACIÓN.
OTRAS VECES ES UNA DECISIÓN.
SOMETIMES HAPPINESS IS A FEELING. SOMETIMES
IT'S A DECISION.
PARFOIS, LE BONHEUR EST UNE SENSATION.
L'AUTRE FOIS EST UNE DECISION.

GRUPO EXOJO

DESIGN

BEDSIDE

SOFT

NORDIC

GIVE YOURSELF TIME

REVOLUTION OF BEDROOMS

CRETA TOP DORMITORIOS



You are *worthy* of love

How they make you feel
says a lot about them
and nothing about you.

Trust me when I say
someone who makes you question
if you are worthy of being loved
is not worthy of being loved by you.

Bianca Sparacino
The Strength In Our Scars

TARSUS N 06

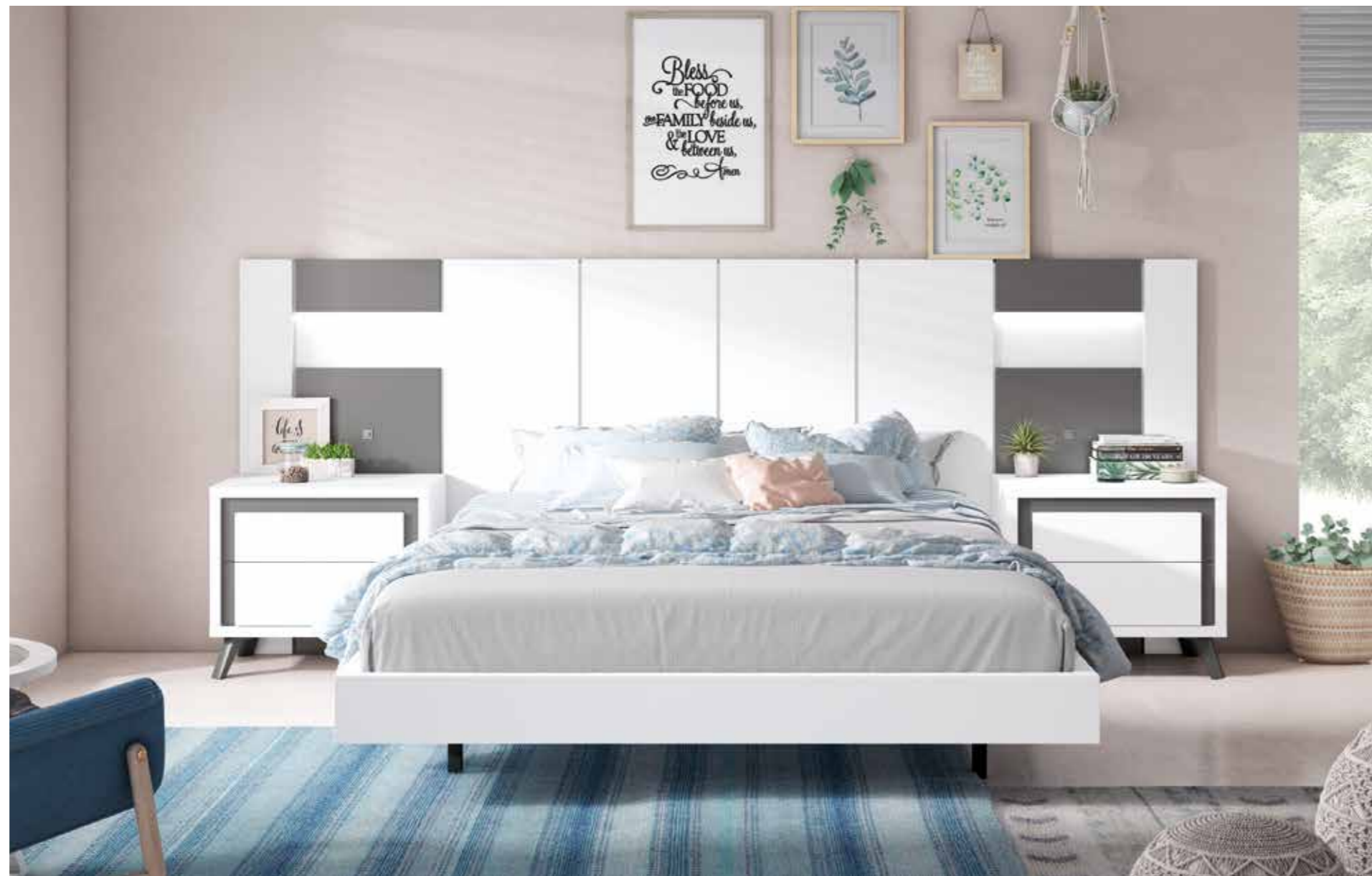

06B BLANCO MATE - GRIS TORMENTA

Diseño y elegancia caracterizan el cabecero TARSUS que en los acabados BLANCO MATE y BORA crean una atmósfera nórdica y acogedora. Detalle de la nueva mesita KAP con interior en acabado efecto cuero y guías ocultas con cierre amortiguado.

Design and elegance characterise the TARSUS xl headboard, which in the finishes BLANCO MATE and BORA creates a nordic and cosy atmosphere. Detail of the new KAP bedside and inside in leather effect finish and hidden runner slides with soft closing.

Design et élégance caractérisent la tête de lit xl TARSUS qui, dans les finitions BLANCO MATE et BORA, crée une atmosphère nordique et accueillante. Détail de la nouvelle table de nuit KAP et de l'intérieur effet cuir et des coulisses cachées avec une fermeture amortie.



INTERIOR
EFECTO CUERO 
Inside in leather effect
Intérieur effet cuir

TARSUS 06

BLANCO MATE - BORA
cabecero TARSUS - bañera TIPO "E" -
mesita KAP - patas HOME

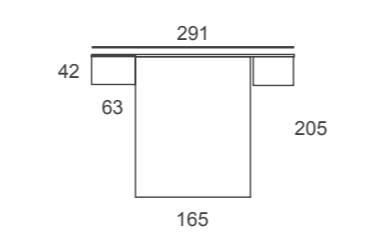

TARSUS con acabado NATURALE inspira un ambiente fresco y auténtico, apoyado por su diseño de líneas rectas.

TARSUS with NATURALE finish inspires a fresh and authentic atmosphere supported by straight line design.

TARSUS avec la finition NATURALE inspire une atmosphère fraîche et authentique soutenue par son design aux lignes droites.

TARSUS 07

NATURALE - VISÓN CHIC
cabecero TARSUS - canapé elevable FORMA -
mesita LUX - sinfonier LUX

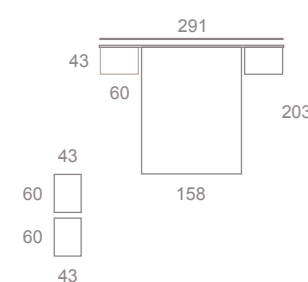



TARSUS 08

SHAMAL - BLANCO MATE
 cabecero TARSUS -
 estante madera - canapé elevable
 RECTO doble apertura -
 mesita KAP - sinfonier KAP -
 mesa escritorio - espejo cuadrado

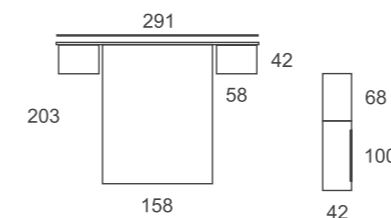

Nuevo sistema de canapé
 elevable con doble posición para
 que tu día a día sea más sencillo.

New system of ottoman bed
 with double position to
 make your day to day easier.

Nouveau système de lit coffre
 avec double position pour vous
 faciliter au jour le jour.



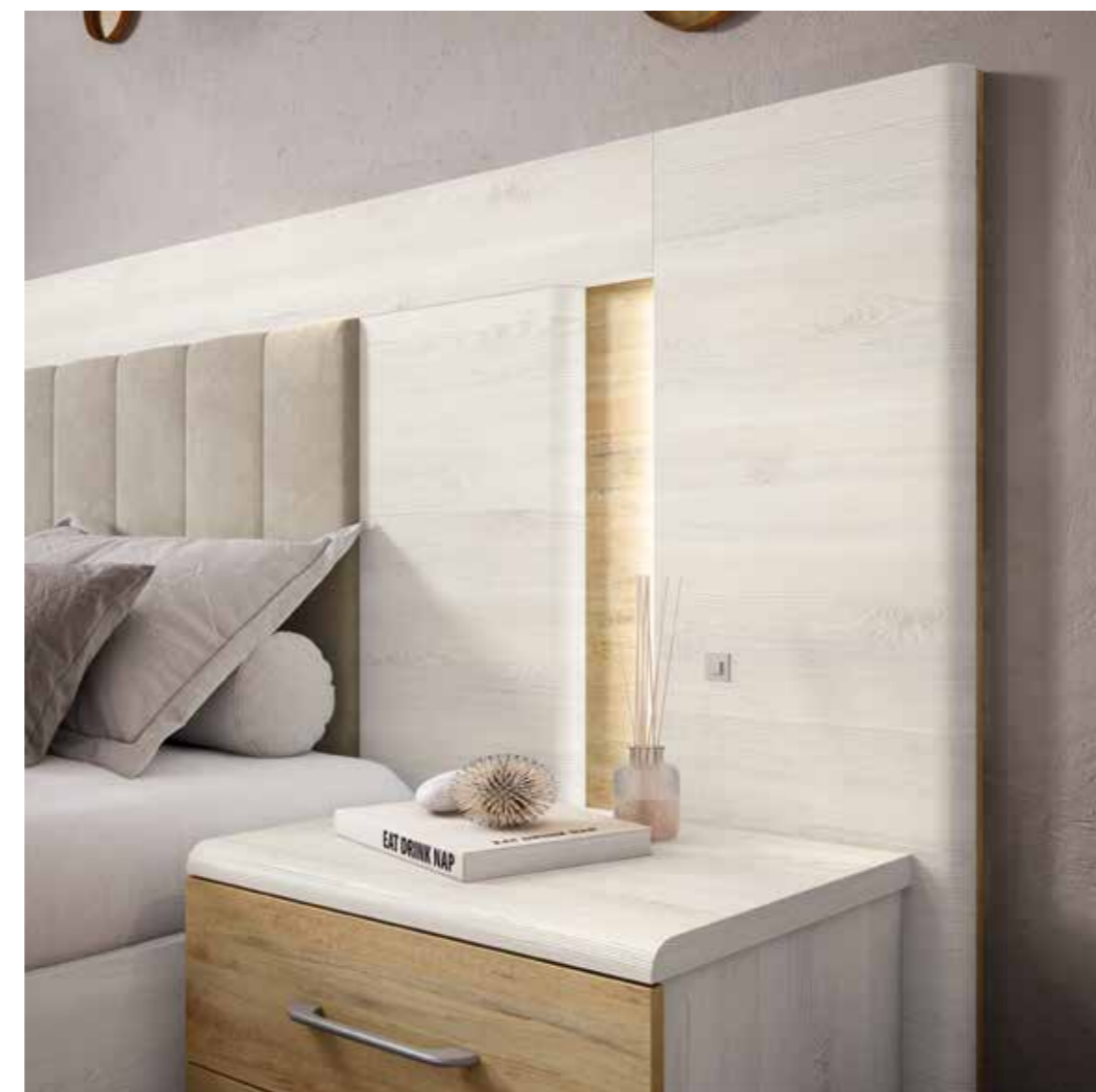
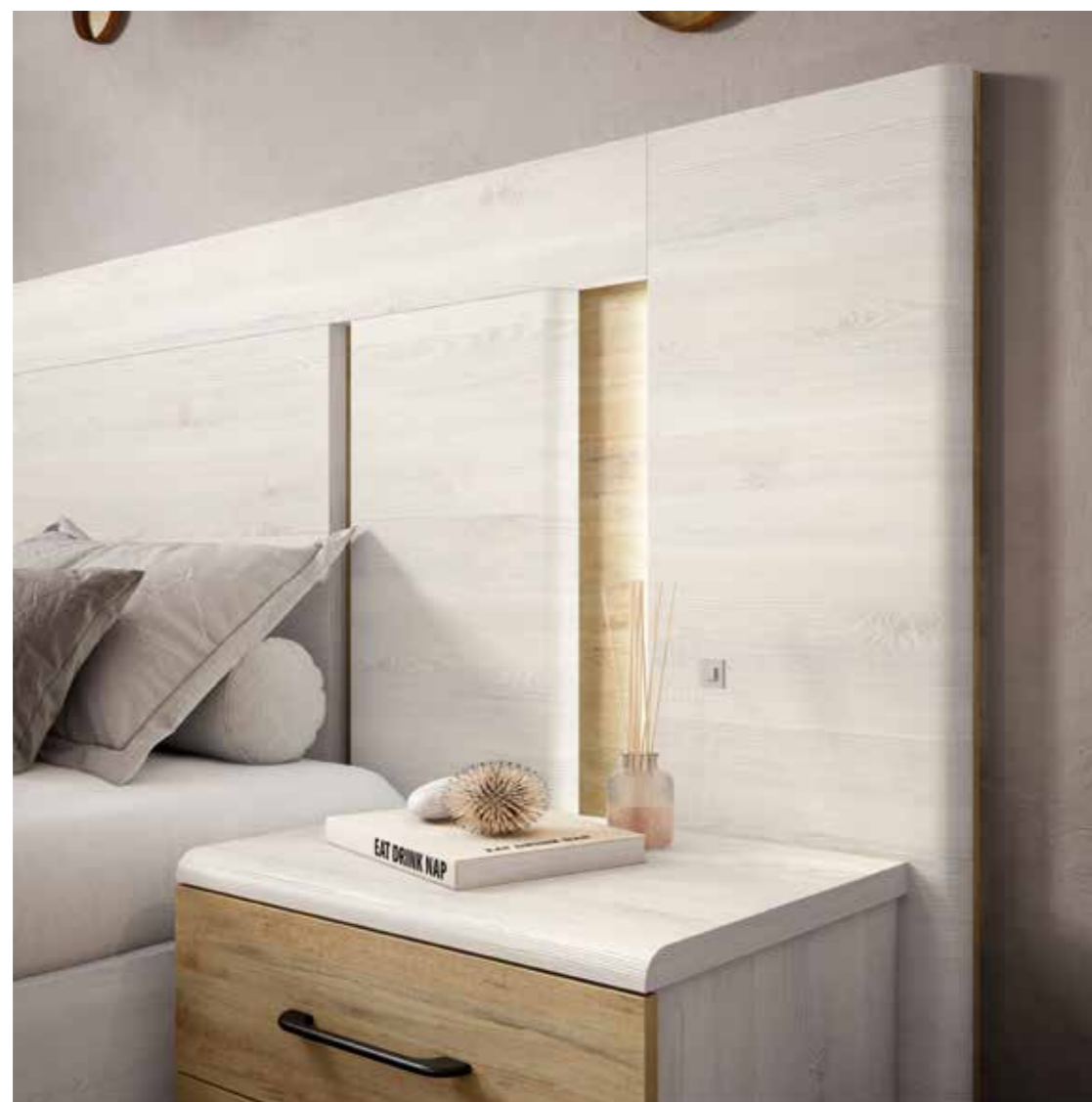

ENNA 09

BLANCO NORDIC - BORA -
TAPIZADO VELVET PETRA -
cabecero ENNA tapizado -
canapé elevable RECTO -
mesita INO tirador LESS grafito -
cómoda INO tirador PLUS grafito -
espejo rectangular

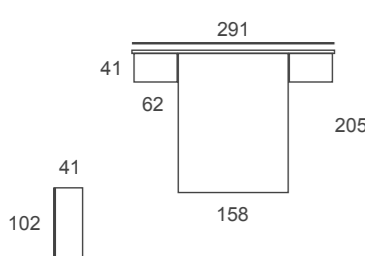

El cabecero ENNA cuenta con la posibilidad de sustituir el panel central por uno tapizado, que con su diseño de formas redondeadas se encuentra en armonía con las formas del cabecero.

Entra y descubre que esconde esta estancia leyendo el código QR.

The ENNA xl headboard has the possibility of replacing the central panel by an upholstered one, this one, with its rounded shape design is in harmony with the shapes of the headboard.

Enter and discover that hides this room reading the code QR.

La tête de lit xl ENNA a la possibilité de remplacer le panneau central par un panneau tapissé que avec son design de forme arrondie s'harmonise avec les formes de la tête de lit.

Entrez et découvrez ce que cette pièce cache en lisant le code QR.



ENNA 10

NATURALE - BLANCO MATE
cabecero ENNA - bañero TIPO "P" -
mesita INO - sinfonier INO - espejo estantería

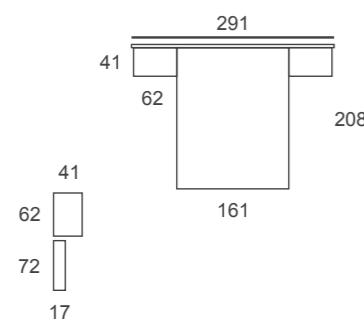

ENNA combina la elegancia clásica con la frescura de los diseños más actuales.
Detalle del cabecero con panel central en tapicería VELVET color ÁGATA.

ENNA combines classic elegance with the freshness of the most up-to-date designs.
Detail of the xl headboard with central VELVET upholstered panel in color ÁGATA.

ENNA combine l'élégance classique avec la fraîcheur des dernières tendances.
Détail de la tête de lit xl avec panneau central en revêtement VELVET couleur ÁGATA.



ENNA 11

SHAMAL - VISIÓN CHIC
cabecero ENNA - bañero TIPO "E" -
mesita TOP

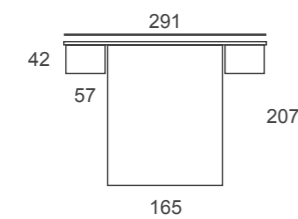

INTERIOR
EFECTO CUERO 
Inside in leather effect
Intérieur effet cuir

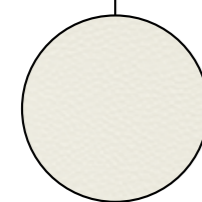

Interior del cajón con acabado efecto cuero y guías ocultas con cierre amortiguado de serie. Un cajón que eleva notablemente la calidad del mueble.
Destacar el grosor de 50mm de la bañera.

Inside of bedside in leather effect finished and hidden runner slides with soft closing that improves the quality of the piece of furniture.
Emphasize the 50mm thickness of the bed base.

Intérieur du tiroir effet cuir et des coulisses cachées avec une Fermeture amortie. Un tiroir qui augmente considérablement la qualité du meuble.
Souligner l'épaisseur de 50 mm de le cadre de lit.



ENNA N 11



A VECES LA FELICIDAD ES UNA SENSACIÓN.
OTRAS VECES ES UNA DECISIÓN.
SOMETIMES HAPPINESS IS A FEELING. SOMETIMES
IT'S A DECISION.
PARFOIS, LE BONHEUR EST UNE SENSATION.
L'AUTRE FOIS EST UNE DECISION.

GRUPO EXOJO

NEW

VISION

DYNAMISM

YOUR WAY OF LIFE

REVOLUTION OF BEDROOMS

DIFERENT

CRETA TOP DORMITORIOS



KOS 12

La nueva serie de auxiliares KAP aporta dinamismo y elegancia a la composición.

Al igual que el resto de series es posible añadirle las diferentes patas que se encuentran en el catálogo: DIAMANTE, RECTAS, NORDICAS y HOME.

Una de las novedades de este catálogo es la incorporación de diferentes bases que le aportan una visión completamente diferente a las mesitas, cómodas y sinfoniers.

The new series KAP of storage units brings dynamism and elegance to the composition.

As the rest of series it is possible to add the different legs that you find in the catalogue: DIAMANTE, RECTAS, NORDICAS and HOME. One of the novelties of this catalogue is the incorporation of different bases that give a completely different vision to the bedside tables, chests of drawers and chifferniers.

La nouvelle série des auxiliaires KAP apporte dynamisme et élégance à la composition.

Comme les autres séries, vous avez la possibilité d'ajouter les différents pieds du catalogue: DIAMANTE, RECTAS, NORDICAS et HOME. Une des nouveautés de ce catalogue est l'incorporation de différentes bases qui apportent une vision complètement différente aux tables de nuit, commodes et chiffonniers.

BLANCO MATE - NATURALE
galería KOS - bañera TIPO "E" -
mesita KAP - sinfonier KAP - base para módulo

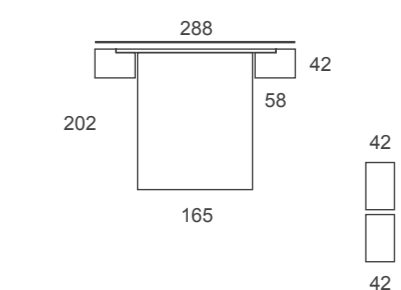



La nueva galería KOS con un diseño desenfadado gracias al contraste entre sus líneas verticales, horizontales y oblicua acentuada por la iluminación led incluida. Los acabados NUDE y BORA crean una atmósfera natural y acogedora.

The new KOS headboard on the bedsides with a casual design thanks to the contrast between the vertical, horizontal and oblique lines accentuated by the led lighting included. The NUDE and BORA finishes create a natural and cosy atmosphere.

La nouvelle tête de lit sur tables de nuit KOS avec un design décontracté grâce au contraste entre ses lignes verticales, horizontales et obliques accentué par l'illumination led incluse. Les finitions NUDE et BORA créent une atmosphère naturelle et accueillante.

KOS 13

NUDE - BORA
galería KOS - mesita KAP

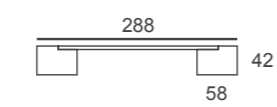



KOS TAPIZADO - VELVET PETRA



KOS TAPIZADO - VELVET ÁGATA



KOS TAPIZADO - VELVET ÓNIX



KOS LISO



14B NUDE

►
ÉPIRO 14

ÉPIRO se caracteriza por su diseño lineal enmarcado por una sencilla pero robusta moldura, que junto con la nueva mesita KAP crea una atmósfera joven, actual y desenfadada.

ÉPIRO is characterized by its linear design framed by a simple but robust frame, which together with the new KAP bedside creates a young, modern and casual atmosphere.

ÉPIRO se caractérise par son design linéaire encadré par une moulure simple mais robuste qui, avec la nouvelle table de nuit KAP, crée une atmosphère jeune, moderne et décontractée.

IRON - BLANCO MATE
cabezal ÉPIRO - bañera TIPO "E" -
mesita KAP - base para módulo

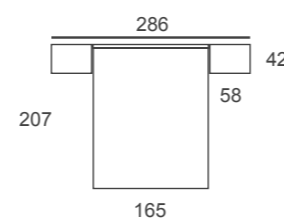

ÉPIRO TAPIZADO N 15



Cabezal ÉPIRO en su versión tapizada disponible en los colores: petra, ágata y ónix.

ÉPIRO headboard in upholstered version available in the colours: petra, ágata and ónix.

Tête de lit ÉPIRO dans sa version tapissée disponible dans les couleurs: petra, ágata et ónix.

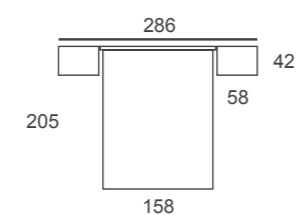

ÉPIRO TAPIZADO 15

BLANCO NORDIC - GRIS TORMENTA - cabezal ÉPIRO TAPIZADO VELVET ÓNIX canapé elevable RECTO - mesita KAP - base para módulo

ÉPIRO LISO N 16



ÉPIRO liso permite combinar su plafón central en todos acabados del catálogo.

ÉPIRO liso allows to combine its central panel in all finishes of the catalogue.

ÉPIRO liso permet combiner son panneau central dans toutes les finitions du catalogue.

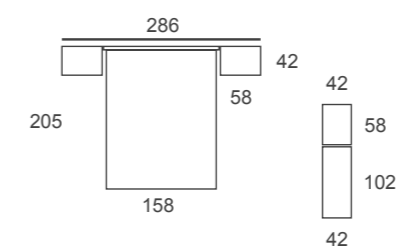

ÉPIRO LISO 16

NUDE - BOCAMINA cabezal ÉPIRO LISO - canapé elevable RECTO - mesita KAP - sinfonier KAP - cómoda KAP -base para módulo

NÁRTHIKA N 17

NÁRTHIKA es el perfecto juego de volúmenes gracias a la combinación de plafones de 16 y 30mm de espesor, acentuados por la iluminación led que incluyen algunos de estos.

NÁRTHIKA is the perfect set of volumes thanks to the combination of 16 and 30mm thickness boards, accentuated by the led lighting that includes some of these boards.

NÁRTHIKA est le jeu de volumes parfait grâce à la combinaison de panneaux de 16 et 30 mm d'épaisseur, accentués par l'illumination led qui comprend certains de ces panneaux.



NÁRTHIKA 17

SHAMAL - GRIS TORMENTA
cabecero NÁRTHIKA - bañera TIPO "E" -
mesita KAP

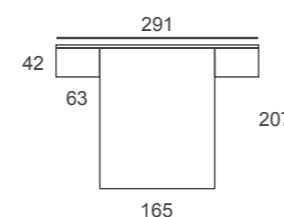



Este cabecero permite sustituir el plafón central por uno tapizado en armonía con el resto de cabecero por su diseño longitudinal. El tapizado velvet se encuentra disponible en 3 colores: PETRA, ÁGATA y ÓNIX.

This xl headboard allows the central panel to be replaced by an upholstered one in harmony with the rest of the headboard by its longitudinal design. The velvet upholstery is available in 3 colours: PETRA, AGATE and ONYX.

Cette tête de lit xl permet remplacer le panneau central par un tapissé en harmonie avec le reste de la tête de lit par son design longitudinal. Le revêtement velvet est disponible en 3 couleurs: PETRA, ÁGATA et ÓNIX.

NÁRTHIKA N 18



NÁRTHIKA 18

FONDO
EFECTO CUERO
Bottom in leather effect
Fond en effet cuir



NATURALE - BLANCO MATE
cabecero NÁRTHIKA - canapé elevable 1 cajón -
mesita TOP - sinfonier TOP

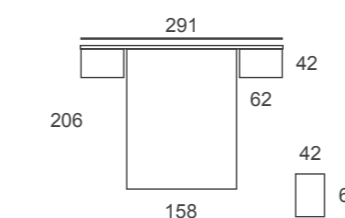

Detalle del canapé elevable con un práctico cajón que combina el almacenamiento para un uso diario y largas temporadas.

Detail of the ottoman bed with a functional drawer that combines storage for daily use and long periods.

Détail du lit coffre avec un pratique tiroir qui combine le rangement pour un usage quotidien et le rangement pour des temps plus prolongé.



GAIA2 se caracteriza por un diseño funcional gracias a sus diferentes puntos de almacenaje. Uno de sus módulos horizontales es opcional y cuenta con una puerta abatible, un hueco e iluminación led incorporada.

GAIA2 is characterised by a functional design thanks to its different storage points. One of its horizontal modules is optional and has a folding door, a hole and led lighting incorporated.

GAIA2 se caractérise par un design fonctionnel grâce à ses différents points de rangement. Un de ses modules horizontaux est optionnel et dispose d'une porte, une niche et illumination led incluse.

GAIA2 19

BLANCO NORDIC - BORA
cabecero GAIA2 - módulo puerta + hueco -
bañera TIPO "E" - mesita KAP -
sínfonier KAP - mesa escritorio

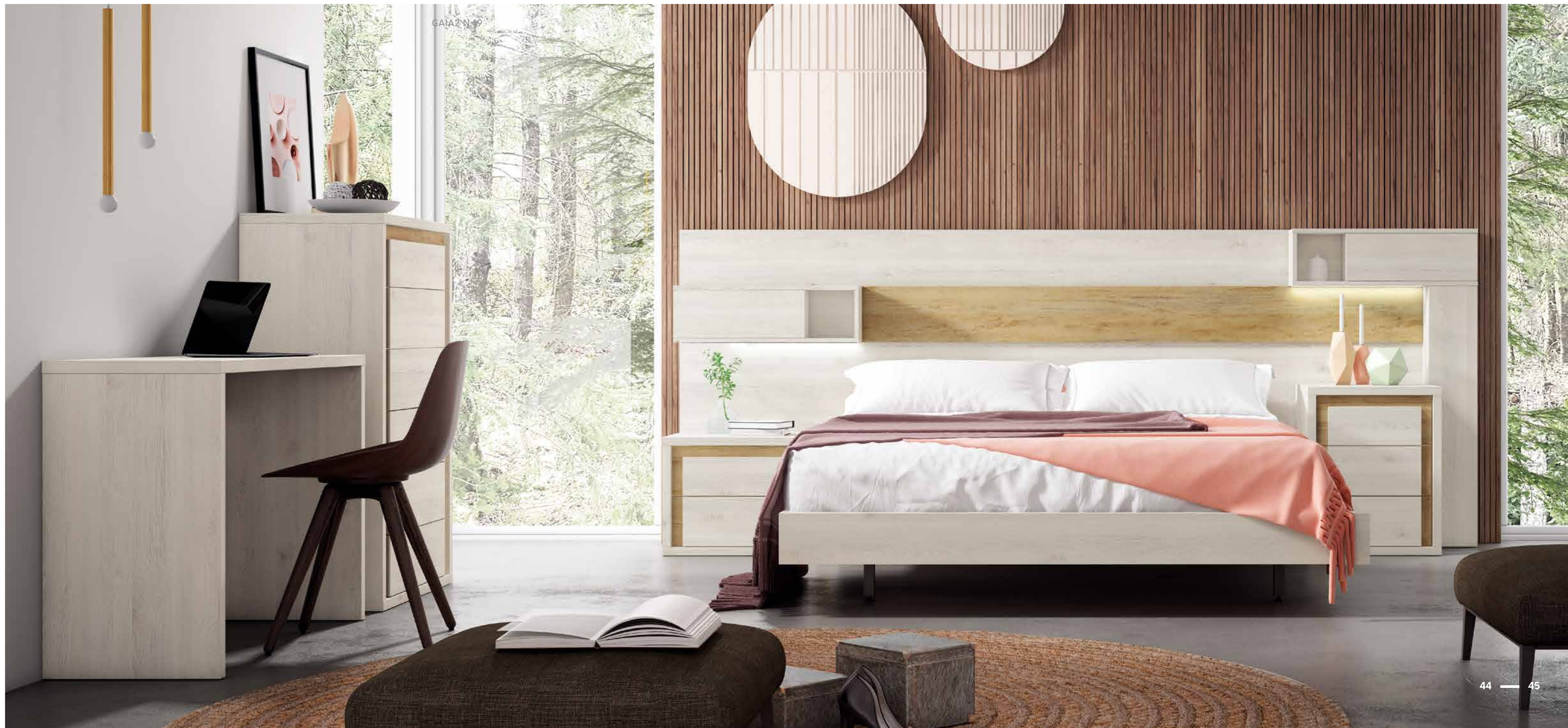
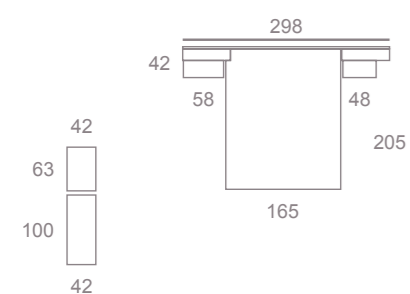

GAIA2 N 19



Detalle de la apertura de los módulos con iluminación incorporada de serie que componen GAIA2, y que aportan un plus de almacenamiento muy útil para su uso diario.

Detail of the opening of the modules with incorporated lighting that compose GAIA2, and that provide a plus of storage very useful for its daily use

Détail de l'ouverture des modules avec illumination incorporée qui composent GAIA2, et qui apportent un plus de stockage très utile pour son utilisation quotidienne.

GAIA2 N 20



GAIA2 20

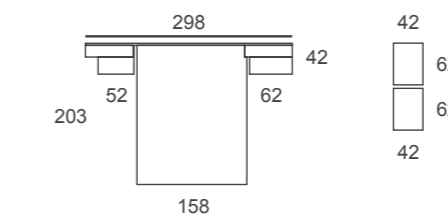

SHAMAL - GRIS TORMENTA
cabecero GAIA2 - módulo puerta + hueco -
canapé elevable FORMA - mesita TOP -
sinfonier TOP

LOFTY



BLANCO MATE BLANCO NORDIC SHAMAL IRON NUDE NATURALE NOCETO

COMFORT

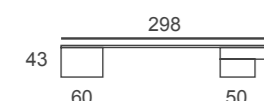

GAIA2 21

IRON - VISÓN CHIC
cabecero GAIA2 - mesita LUX



A VECES LA FELICIDAD ES UNA SENSACIÓN.
OTRAS VECES ES UNA DECISIÓN.
SOMETIMES HAPPINESS IS A FEELING. SOMETIMES
IT'S A DECISION.
PARFOIS, LE BONHEUR EST UNE SENSATION.
L'AUTRE FOIS EST UNE DECISION.

GRUPO EXOJO



CRETA TOP DORMITORIOS





Ambiente que se caracteriza por las terminaciones redondeadas que aportan las piezas postformadas de 30mm de espesor, como podemos ver en el detalle de la bañera tipo "p" y en el detalle del cabecero.

A space characterized by the rounded ends provided by the 30mm thickness postformed pieces, as we can see in the detail of the bed base tipo "p" and in the detail of the xl headboard.

Espace caractérisé par les formes arrondies des pièces postformées de 30 mm d'épaisseur, comme on peut voir dans les détails de le cadre de lit tipo "p" et dans le détail de la tête de lit xl.

GARONA 22

SHAMAL - VISÓN CHIC
cabecero GARONA - bañera TIPO "P" -
mesita INO - sinfonier INO - panel espejo

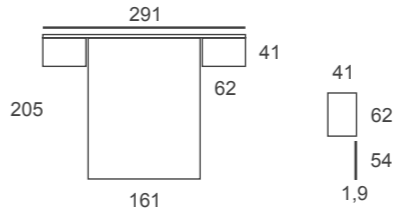



GARONA N 23

GARONA 23

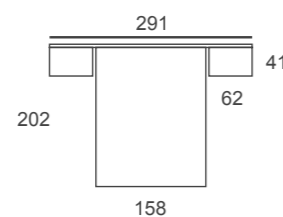

NUDE - GRIS TORMENTA
 cabecero GARONA - canapé elevable FORMA -
 mesita INO



GARONA N 24

GARONA 24

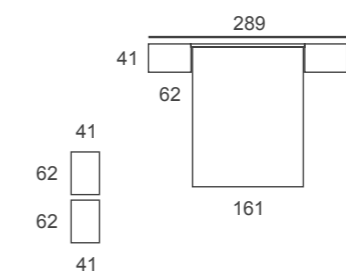

NATURALE
 cabecero GARONA - bañera TIPO "P" -
 mesita INO tirador LESS grafito -
 sinfonier INO tirador LESS grafito - patas HOME



Los armarios de rincón son perfectos para aprovechar hasta el último rincón de la casa sin perder espacio de almacenaje. Con un interior en acabado efecto cuero y con la posibilidad de completarlo con cajoneras, estantes interiores, iluminación led...

The corner wardrobes are perfect to take advantage of every corner of the house without losing storage space. With an inside in leather effect finished and with the possibility of completing it with drawers, interior shelves, led lighting...

Les armoires d'angle sont parfaites pour profiter de chaque coin de la maison sans perdre espace de rangement. Avec un intérieur en effet cuir et la possibilité de le compléter avec de modules intérieurs de tiroirs, tableaux intérieurs, illumination led...



INTERIOR
EFECTO CUERO 
Inside in leather effect
Intérieur effet cuir

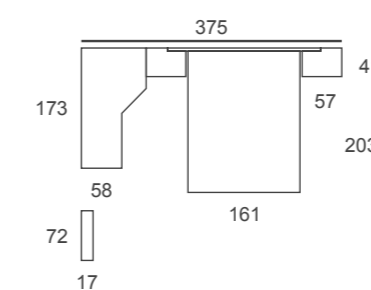

GARONA 25

IRON - BOCAMINA
galería GARONA - bañera TIPO "P" -
mesita INO tirador LESS grafito - espejo estantería -
armario rincón puertas plegables tirador PLUS grafito

REGIO 26

NATURALE - GRIS TORMENTA
cabecero REGIO - caja panel -
bañera TIPO "P" - mesita INO

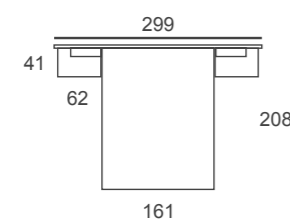

El cabecero REGIO tiene la posibilidad
de completarse con diferentes accesorios
para tus detalles.

The REGIO xl headboard has the
possibility of being completed with different
accessories for your details.

La tête de lit xl REGIO offre la possibilité
de la compléter avec différents accessoires
pour vos détails.



CARGADOR Y LÁMPARA USB / CHARGER AND USB LAMP /
CHARGEUR ET LUMIÈRE USB.



ESTANTE CRISTAL / GLASS SHELF / ÉTAGÈRE EN VERRE



CAJA PANEL / WOODEN CUBE / CUBE BOIS



CAJA CRISTAL PANEL / WOOD-GLASS CUBE / CUBE BOIS-VERRE



CAJA PUERTA PANEL / WOODEN CUBE WITH 1 DOOR /
CUBE BOIS AVEC 1 PORTE



ESTANTE MADERA / WOODEN SHELF /
ÉTAGÈRE BOIS



REGIO N 27

REGIO 27

IRON - STONE ROCK
cabecero REGIO - bañera TIPO "E" -
mesita LUX - sinfonier LUX -
módulo baúl zapatero

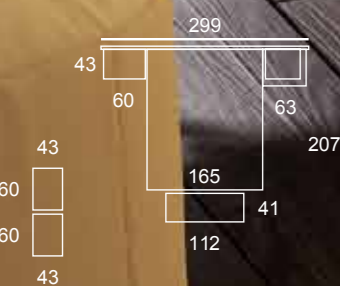

Detalle de la apertura del baúl zapatero, un singular mueble con doble utilidad en el mínimo espacio.

Detail of the open shoe trunk. It's a very useful piece of furniture with doubleusefulness in the minimum available space.

Détail de l'ouverture du coffre de chaussures. Un meuble singulier avec une double utilité dans un minimum d'espace.



Detalle de la iluminación led que incorpora este modelo de cabecero, y conexión para carga usb.

Detail of the led lighting incorporated in this model of headboard, and for charge usb.

Détail de l'illumination led qui intègre ce modèle de tête de lit, et connexion pour charge usb.



Detalle del cabecero REGIO con las mesitas LUX de 1 cajón apiladas, quedando enrasadas con la parte superior de la bañera.

Detail of the REGIO xl headboard with the LUX bedside of 1 drawer stacked, being levelled with the top of the bed base.

Détail de la tête de lit xl REGIO avec les tables de nuit LUX de un tiroir superposées, au même niveau que le cadre de lit.



REGIO 27



NIKAIA 28

NIKAIA N 28

Detalle del acabado redondeado de la mesita INO donde También podemos ver el interior de los cajones en acabado efecto cuero y las guías ocultas con cierre amortiguado, una apuesta por la calidad y la elegancia.

Detail of the rounded finishes of the INO bedside where also we can see the inside of the drawers in effect leather finish and hidden runner slides with soft closing. An investment for the quality and the elegance.

Détail de la finition arrondie de la table de nuit INO où on peut voir l'intérieur effet cuir et des coulisses cachées avec une fermeture amortie. Une mise sur la qualité et l'élégance.

NUDE - BLANCO MATE

cabecero NIKAIA - módulo puerta + hueco -
bañera TIPO "P" - mesita INO - sinfonier INO

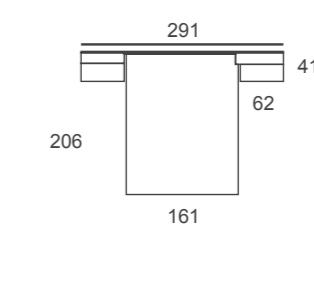

INTERIOR
EFECTO CUERO 
Inside in leather effect
Intérieur effet cuir

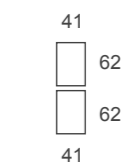

El cabecero NIKAIÁ cuenta con un diseño actual y fresco acorde a las últimas tendencias. Sus formas curvas y su práctico estante es el elemento característico de este cabecero, que junto con la posibilidad de incorporar un módulo de 1 puerta + hueco con led hace que la sencillez de un paso adelante cobrando un significado diferente.

The NIKAIÁ xl headboard has a modern and fresh design according to the latest trends. Its curved shapes and practical shelf is the characteristic element of this headboard, which together with the possibility of incorporating a module of 1 door + hole with led makes the simplicity of a step forward taking on a different meaning.

La tête de lit xl NIKAIÁ a un design moderne et frais selon les dernières tendances. Ses formes courbes et sa pratique étagère sont l'éléments caractéristique de cette tête de lit. Il y a la possibilité d'incorporer un module de 1 porte + niche et illumination led, ce qui fait que la simplicité donne une pas en avant en prenant un sens différent.



NIKAIA 29

BLANCO MATE - NOCETO
cabecero NIKAIÁ - módulo puerta + hueco -
mesita INO



A VECES LA FELICIDAD ES UNA SENSACIÓN.
OTRAS VECES ES UNA DECISIÓN.
SOMETIMES HAPPINESS IS A FEELING. SOMETIMES
IT'S A DECISION.
PARFOIS, LE BONHEUR EST UNE SENSATION.
L'AUTRE FOIS EST UNE DECISION.

GRUPO EXOJO

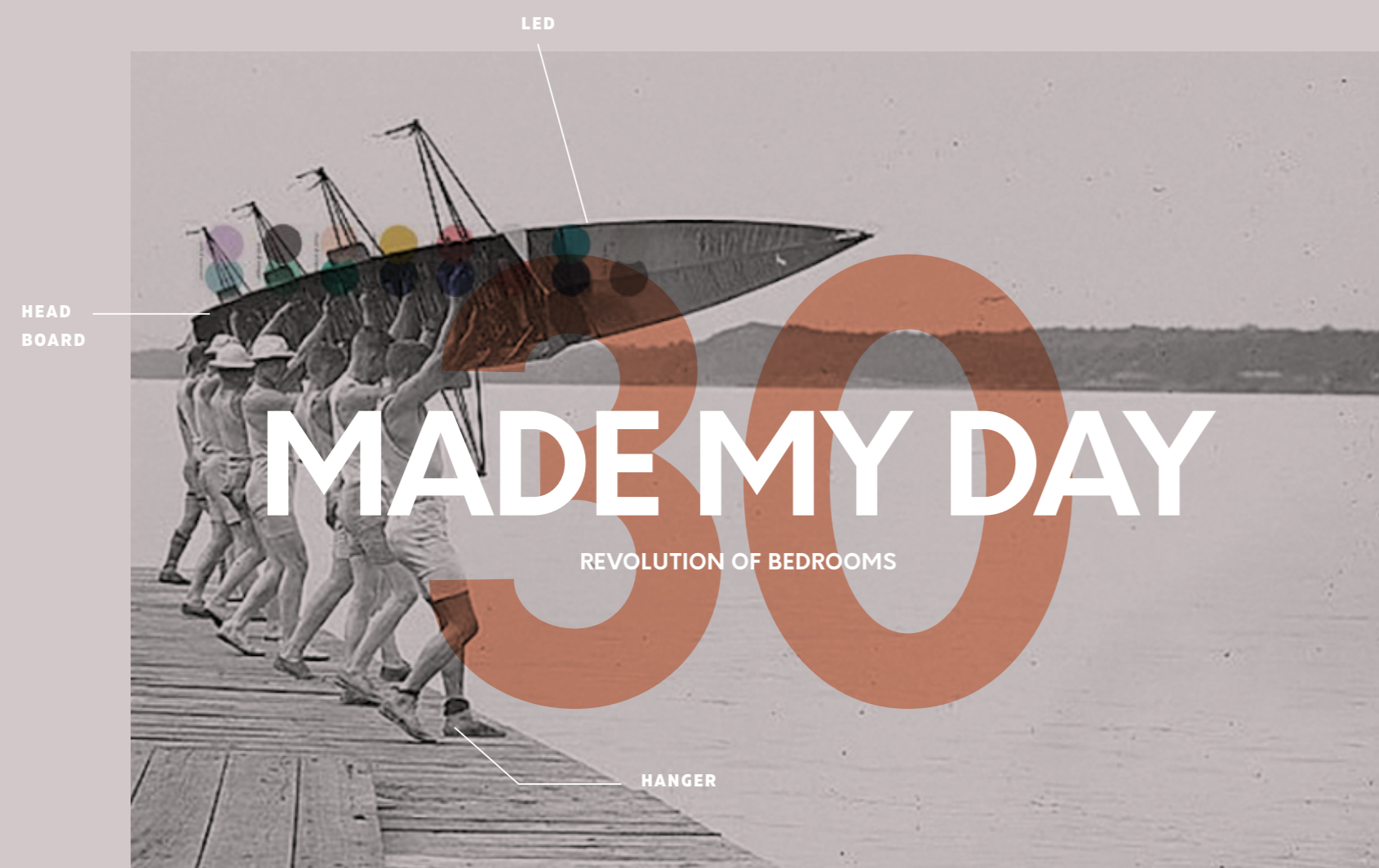

CRETA TOP DORMITORIOS



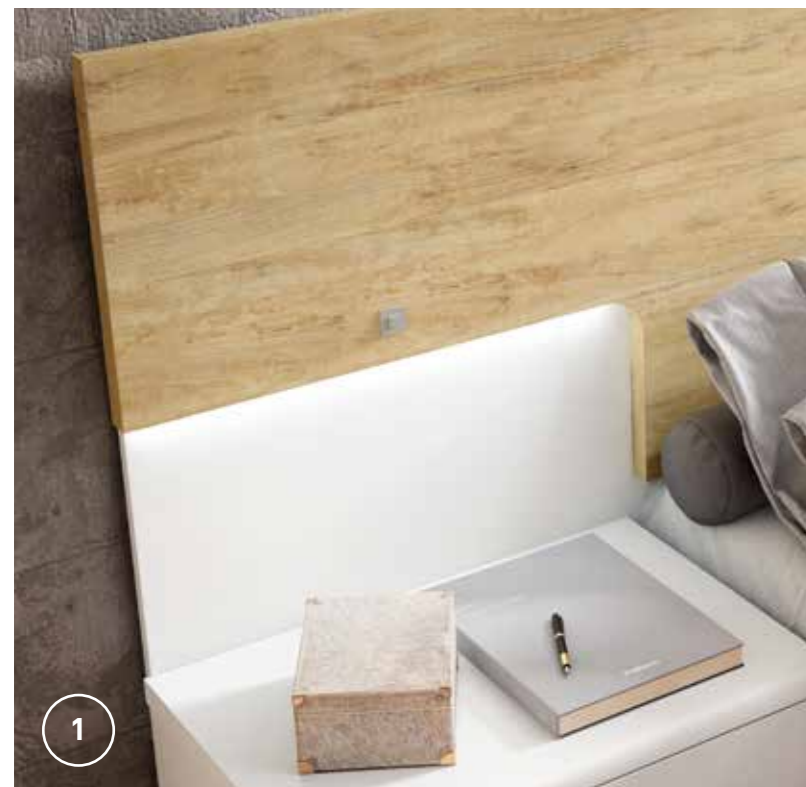

Detalle de la iluminación led del cabecero QUIOS (1) y del espejo con perchero desplegable (2) muy útil para el uso diario.

Detail of the led lighting of the QUIOS xl headboard (1) and of the mirror with folding hanger (2) very useful for the daily use.

Détail de l'illumination led de la tête de lit xl QUIOS (1) et du miroir avec porte-manteau (2) très utile pour son utilisation quotidienne.

QUIOS 30

BLANCO MATE - BORA
cabecero QUIOS - bañera TIPO "P" -
mesita INO - sinfonier INO -
espejo con perchero

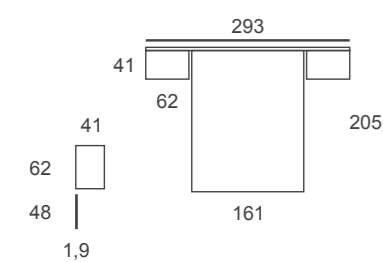



Detalle de la mesita LUX con la nueva pata home.
Esta serie permite desmontar la base y poner las patas directamente si se desea.

Detail of the LUX bedside with the new home leg.
This series allows you to remove the base and put the legs directly.

Détail de la table de nuit LUX avec le nouveau pied home.
Cette série vous permet de démonter la base et de placer les pieds directement si vous le désirez.



Canapé elevable con puerta abatible, muy funcional y práctico para un uso diario o largas temporadas de almacenamiento.

Ottoman bed with folding door, very useful and practical for daily use or long storage periods.

Lit coffre avec porte rabattable, très fonctionnel et pratique pour une utilisation quotidienne ou rangement pour des temps plus prolongé.



QUIOS 31

NATURALE - BOCAMINA
cabecero QUIOS - canapé elevable 1 puerta -
mesita LUX - cómoda LUX - patas HOME

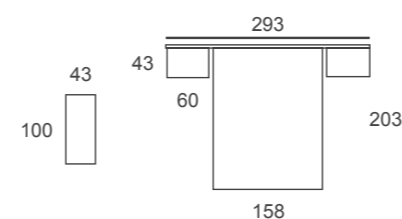

FONDO
EFECTO CUERO 
Bottom in leather effect
Fond en effet cuir

HEBE 32



NUDE
cabecero HEBE - bañera TIPO "P" -
mesita INO tirador LESS grafito -
cómoda INO tirador PLUS grafito

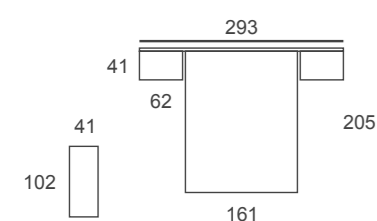

El cabecero HEBE ofrece un diseño
Moderno, que con sus formas sinuosas
enmarcadas en formas rectas, crea un
equilibrio sereno y elegante que no
deja indiferente a nadie.

The HEBE xl headboard offers a modern
design, whose sinuous forms framed
in straight forms create a serene
and elegant harmony that leaves no one
indifferent.

La tête de lit xl HEBE offre un design
moderne, qui avec ses formes sinueuses
encadrées dans des formes droites,
crée un équilibre serein et élégant qui
ne laisse personne indifférent.





HEBE 33

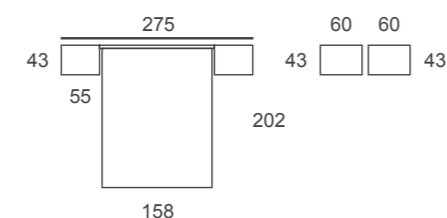

IRON
cabezal HEBE - canapé elevable RECTO -
mesita LUX - sinfonier LUX



HEBE 34

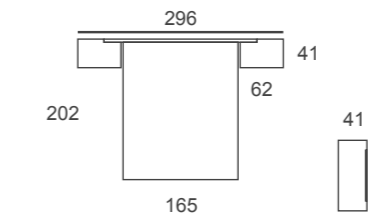

BLANCO MATE
galería HEBE - bañera TIPO "E" -
mesita INO - cómoda INO - espejo cuadrado

HEBE 35

NATURALE - BOCAMINA
galería HEBE - bañera TIPO "E" -
mesita TOP - cómoda TOP -
armarios puertas batientes tirador LESS grafito -
estantería

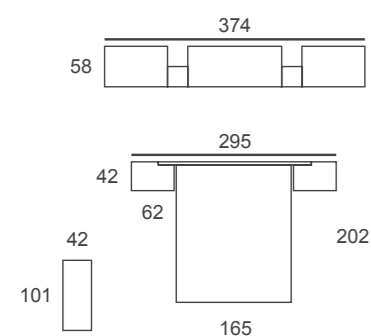

HEBE N 35



Lo natural cobra sentido en esta composición gracias a los nuevos acabados naturale y bocamina creando una atmosfera cálida y acogedora.

The natural makes sense in this composition thanks to the new finishes naturale and bocamina that create a cosy atmosphere.

Le naturel prend tout son sens dans cette composition grâce aux nouvelles finitions naturale et bocamina qui créent une atmosphère accueillante.

HADES 36

NOCETO - BOCAMINA
 cabezal HADES - bañera TIPO "E" -
 mesita KAP - sinfonier KAP -
 base para módulo

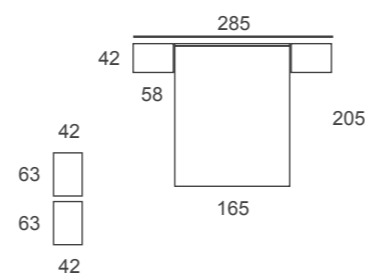

Detalle de sinfonier en color blanco mate - noceto y con la nueva pata home en color grafito. Una variante de color diferente y elegante.

Chiffonnie in blanco mate - noceto and with the new leg home in colour grafito. A different and elegant colour version.

Chiffonnier en couleur blanco mate - noceto et pied home en couleur grafito. Une combinaison différente et élégante.



A VECES LA FELICIDAD ES UNA SENSACIÓN.
OTRAS VECES ES UNA DECISIÓN.
SOMETIMES HAPPINESS IS A FEELING. SOMETIMES
IT'S A DECISION.
PARFOIS, LE BONHEUR EST UNE SENSATION.
L'AUTRE FOIS EST UNE DECISION.

GRUPO EXOJO

SPECIAL

PLUS

SPACE

GOODLY HOUSE

REVOLUTION OF BEDROOMS

STORAGE

CRETA TOP DORMITORIOS



Simple
Life

HADES N 37



(1) Detalle de la apertura del canapé elevable con un fondo en acabado efecto cuero y base tapizada con aireadores para el colchón, que aporta un plus de espacio de almacenaje a la estancia.
(2) Banqueta zapatero tapizada, una pieza muy útil e indispensable en todo dormitorio. El tapizado VELVET se encuentra disponible en 3 colores: petra, ágata y ónix.

(1) Detail of the opening of the ottoman bed with a leather effect bottom and an upholstered base with mattress aerators, which adds extra storage space to the room.
(2) This upholstered shoe rack is a very special piece that becomes very useful and essential in every bedrooms. You can choose 3 options of velvet upholstery: petra, ágata and ónix.

(1) Détail de l'ouverture du lit coffre avec fond en effet cuir et plateau tapissé avec aérateurs pour matelas, ce qui augmente l'espace de rangement dans la pièce.
(2) Banc pour chaussures tapissé, une pièce très utile et indispensable dans toute chambre à coucher. Le revêtement VELVET est disponible en 3 couleurs: petra, ágata et ónix.

HADES 37

NATURALE - BLANCO MATE -
TAPIZADO VELVET PETRA -
cabecero HADES - caja panel -
canapé elevable RECTO - mesita KAP -
cómoda KAP - espejo cuadrado
módulo banqueta zapatero tapizado 110cm.

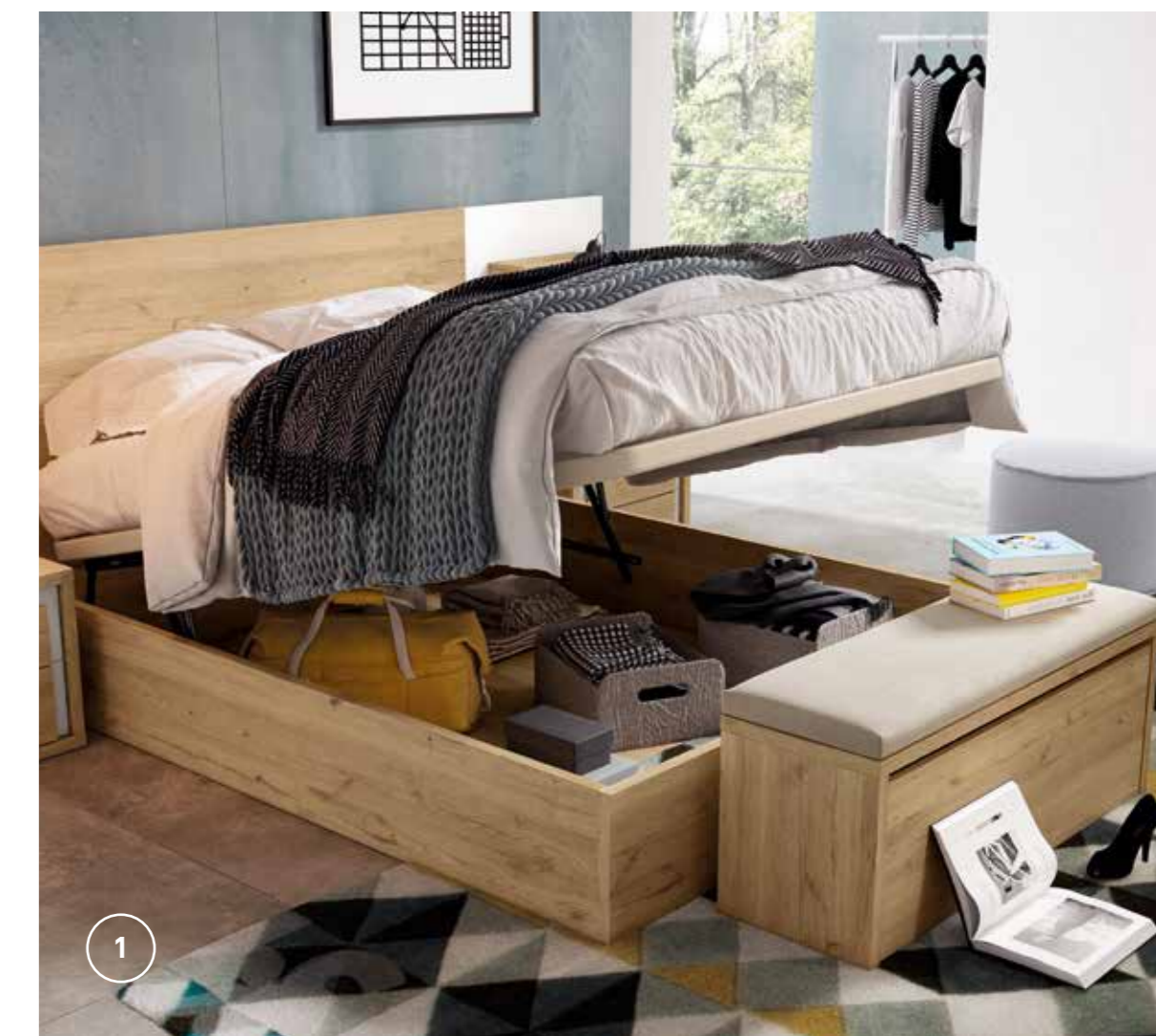
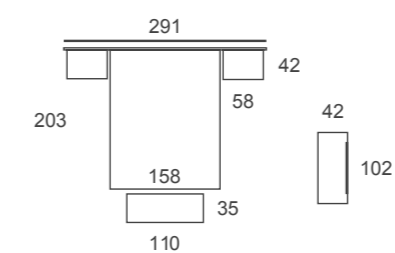



AURA RED 38

La elegancia de la mesita ino junto a la sencillez del tirador less aporta al ambiente un toque muy actual.

The elegance of the ino bedside combined with the simplicity of the less handle gives the atmosphere a very modern touch.

L'élégance de la table de nuit ino et la simplicité de la poignée less confèrent à la pièce une touche très actuelle.

SHAMAL - BLANCO MATE
cabezal AURA RED - bañera TIPO "P"
mesita INO tirador LESS grafito -
sinfonier INO tirador LESS grafito

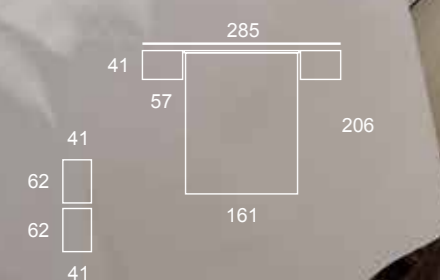



AURA 39

BLANCO NORDIC - VISIÓN CHIC
cabezal AURA - bañera TIPO "E" - mesita LUX -
cómoda LUX - marco espejo cuadrado

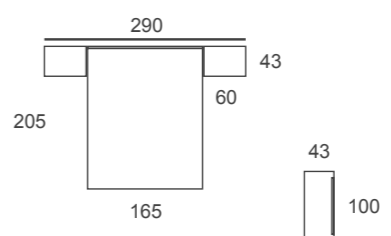

El cabezal AURA cuenta con un marco con un diseño elegante y sencillo disponible en todos los colores base del catálogo Creta Top.

The AURA headboard has a frame with an elegant and simple design available in all the base colours of the creta top catalogue.

La tête de lit AURA a un cadre avec un design élégant et simple disponible dans toutes les couleurs base du catalogue Creta Top.



HEBROS 40

BLANCO MATE - BORA
cabezal HEBROS - bañera TIPO "E" -
mesita LUX - sinfonier LUX -
patas NORDICAS

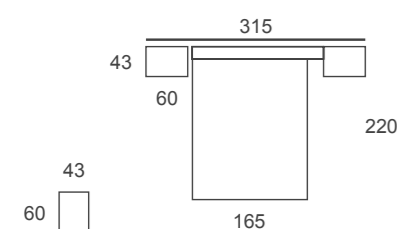

HEBROS N 40

La mesita LUX permite desmontar la base, que viene incluida, para poner directamente alguna de las diferentes patas que podemos encontrar en este catálogo, cómo podemos ver en este detalle de la mesita con la pata nordica. O bien, si se desea, se pueden poner las patas a la base.

The LUX bedside allows you to remove the base, which is included, to put directly some of the different legs that we can find in this catalogue, as we can see in this detail of the bedside with the leg nordica. Or, if you wish, you can put the legs at the base.

La table de nuit LUX permet le démontage de la base, qui est incluse, pour placer directement les différents pieds que l'on trouve dans ce catalogue, comme on peut voir dans ce détail de la table de nuit avec le pied nordica. Ou si vous voulez, vous pouvez placer les pieds à la base.

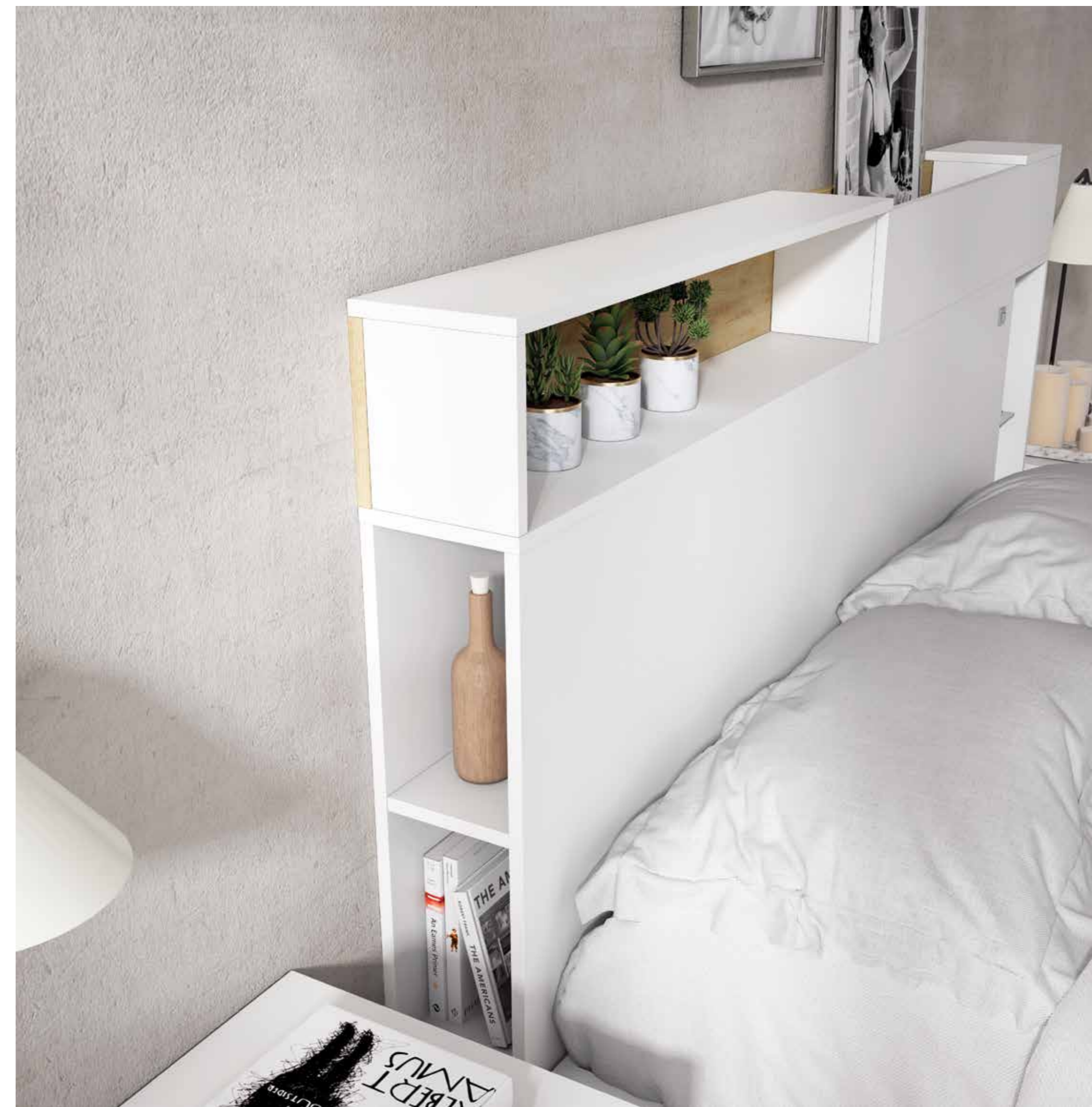

Cabezal HEBROS con gran cantidad de huecos y repisas para un estilo de vida dinámico, joven y desenfadado.

The HEBROS headboard with lots of openings and shelves for a dynamic, young and casual lifestyle.

Tête de lit HEBROS avec de nombreuses ouvertures et étagères pour un style de vie dynamique, jeune et décontracté.

A VECES LA FELICIDAD ES UNA SENSACIÓN.
OTRAS VECES ES UNA DECISIÓN.
SOMETIMES HAPPINESS IS A FEELING. SOMETIMES
IT'S A DECISION.
PARFOIS, LE BONHEUR EST UNE SENSATION.
L'AUTRE FOIS EST UNE DECISION.

GRUPO EXOJO

VERTICAL

COLOUR

BED

MADE MY DAY

REVOLUTION OF BEDROOMS

INSIDE

CRETA TOP DORMITORIOS





Cama abatible vertical con puerta elevable en la parte superior, interior en acabado efecto cuero. Cuenta con un cabecero tapizado VELVET disponible en 3 colores: petra, ágata y ónix. (1), (2), (3) Posicionamiento automático y sincronizado de la pata, muy cómodo y fácil de usar.

Vertical wall bed with elevating door in the top part, inside in leather effect finished. It counts on a VELVET upholstered headboard available in 3 colors: petra, ágata and ónix. (1), (2), (3) Automatic and synchronized positioning of the leg, very comfortable and easy to use.

Lit escamotable vertical avec porte relevable dans la partie supérieure, intérieur en effet cuir. La tête de lit est tapissée disponible en 3 couleurs: petra, ágata et ónix. (1), (2), (3) Positionnement automatique et synchronisé des pieds, très confortable et facile à utiliser.



ABATIBLE V 41

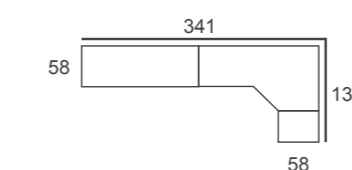

BLANCO NORDIC - TAPIZADO ÁGATA
abatible VERTICAL tirador LESS grafito -
armario rincón P. plegables tirador PLUS grafito -
terminal zapatero - estantes

ABATIBLE HORIZONTAL N 42



ABATIBLE H 42

SHAMAL - GRIS TORMENTA
abatible HORIZONTAL tirador LESS grafito -
armario 1P. + 5C. tirador LESS grafito -
armario 2P. tirador LESS grafito

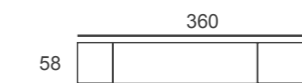

Cama abatible horizontal disponible en 135 y 150cm. De ancho por 190cm. de largo, con puertas superiores plegables e interior en acabado efecto cuero. La cama cuenta con un bastidor en aluminio lacado blanco para mayor resistencia y ligereza, lamas de madera, pistones protegidos con cubre pistones, uno de ellos con led, y apertura automática de las patas.

Horizontal wall bed available in 135 and 150cm. Width and 190cm length. The bed is made in white lacquered aluminium frame which makes it stronger and lighter. They also have wooden slats and pistons protected with piston covers, one of them with led, and automatic positioning of the legs.

Lit escamotable horizontal disponible en 135 et 150 cm. de large par 190cm. de long, avec portes pliantes et un intérieur en effet cuir. Le lit est équipé avec un cadre en aluminium laqué blanc pour plus de résistance et de légèreté, des lattes en bois, des pistons protégés par des couvercles de piston, un avec led, et ouverture automatique des pieds.

PUERTA **LISA** CON TIRADOR **PLUS** (cajones siempre tirador Less)



PUERTA **LISA** CON TIRADOR **LESS**



PUERTA **BICOLOR** SIEMPRE TIRADOR **LESS**



PUERTA **TRIO** SIEMPRE CON TIRADOR **LESS**

PUERTA **RAW**

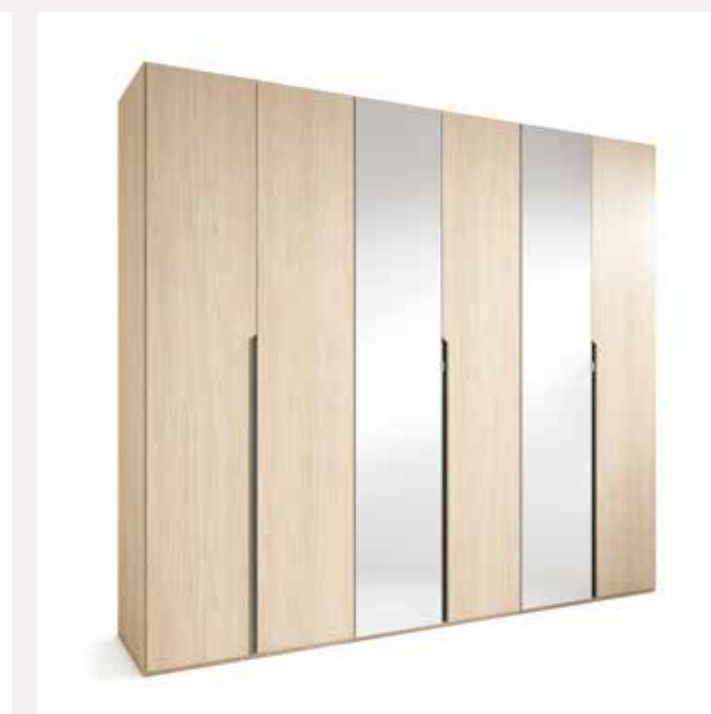

MEDIDAS:

1P. 41, 46, 51 cm.

2P. 81, 91, 101 cm.

3P. 120, 125, 130, 135, 140, 145, 150 cm.

4P. 159, 160, 170, 179, 180, 190, 199, 200 cm.

5P. 199, 204, 209, 219, 224, 229, 239, 244, 249 cm.

6P. 238, 248, 258, 268, 278, 288, 298 cm.

PUERTAS PLEGABLES

PUERTA LISA



PUERTA DUO



PUERTA TRIO



PUERTA LISA + LUNA



PUERTA LISA + LUNA



PUERTA LISA + LUNA



MEDIDAS:

- 2P. 81, 91, 101 cm.
- 3P. 120, 135, 150 cm.
- 4P. 159, 179, 199 cm.
- 5P. 199, 224, 249 cm.
- 6P. 238, 268, 298 cm.

PUERTAS CORREDERAS

PUERTA LISA + LUNA



PUERTA TRIO



PUERTA BASS



PUERTA ZAG



PUERTA ZAG LUNA



PUERTA RUS



3 PUERTAS TRIO



3 PUERTAS ZAG + LUNA



MEDIDAS:

- 159, 179, 199, 219 cm.

MEDIDAS:

- 238, 268 cm.



Nuevo sistema de puertas plegables para que la accesibilidad al interior del armario sea completa, sin obstáculos.

New system of folding doors for complete accessibility to the inside of the wardrobe, without obstacles.

Nouveau système de portes pliantes pour un accès complet et sans obstacles à l'intérieur de l'armoire.

ARMARIO 01

NUDE - STONE ROCK
armario 4P. plegables tirador PLUS grafito

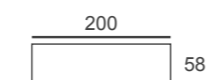

ARMARIO N 02



ARMARIO 02 SHAMAL - BOCAMINA
 armario 5P. + 5C. puertas BICOLOR
 tirador LESS grafito

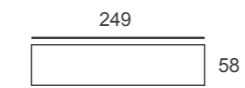

ARMARIO N 03



ARMARIO 03 BLANCO MATE - BORA
 armario 2P. tirador LESS grafito - estantería -
 armario 3P. + 5C. tirador LESS grafito





El nuevo módulo de tv marcará un antes y un después en la estancia. Su doble fondo permite, a la hora de su montaje, apoyar la tv en la base o colgarla (soportes tv no incluidos). Este módulo se completa con un práctico módulo superior de dos puertas con push y una amplia cómoda de cuatro cajones, con los que aprovechas al máximo el espacio de almacenaje.

The new tv module will mark a before and an after in the room. Its double bottom allows, at the time of its assembly, to support the tv in the base or to hang it (tv supports not included). This module is completed with a practical two-door top unit with push and a chest of drawers of 4 drawers, with which you make the most of the storage space.

Le nouveau module tv marquera un avant et un après dans la pièce. Son double fond permet, lors de son montage, de placer le téléviseur sur la base ou de la suspendre (supports tv non inclus). Le module se complète avec un pratique module supérieur de deux portes avec push et une commode de quatre tiroirs, pour un maximum d'espace de rangement.



ARMARIO 04

NATURALE - VISÓN CHIC
armario 2P. tirador RAW grafito -
módulo tv tirador RAW grafito

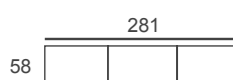

ARMARIO 05

BLANCO MATE - BORA
 armario 3P. - armario rincón 1P. -
 armario 6P. - tirador LESS plateado -
 barra led exterior

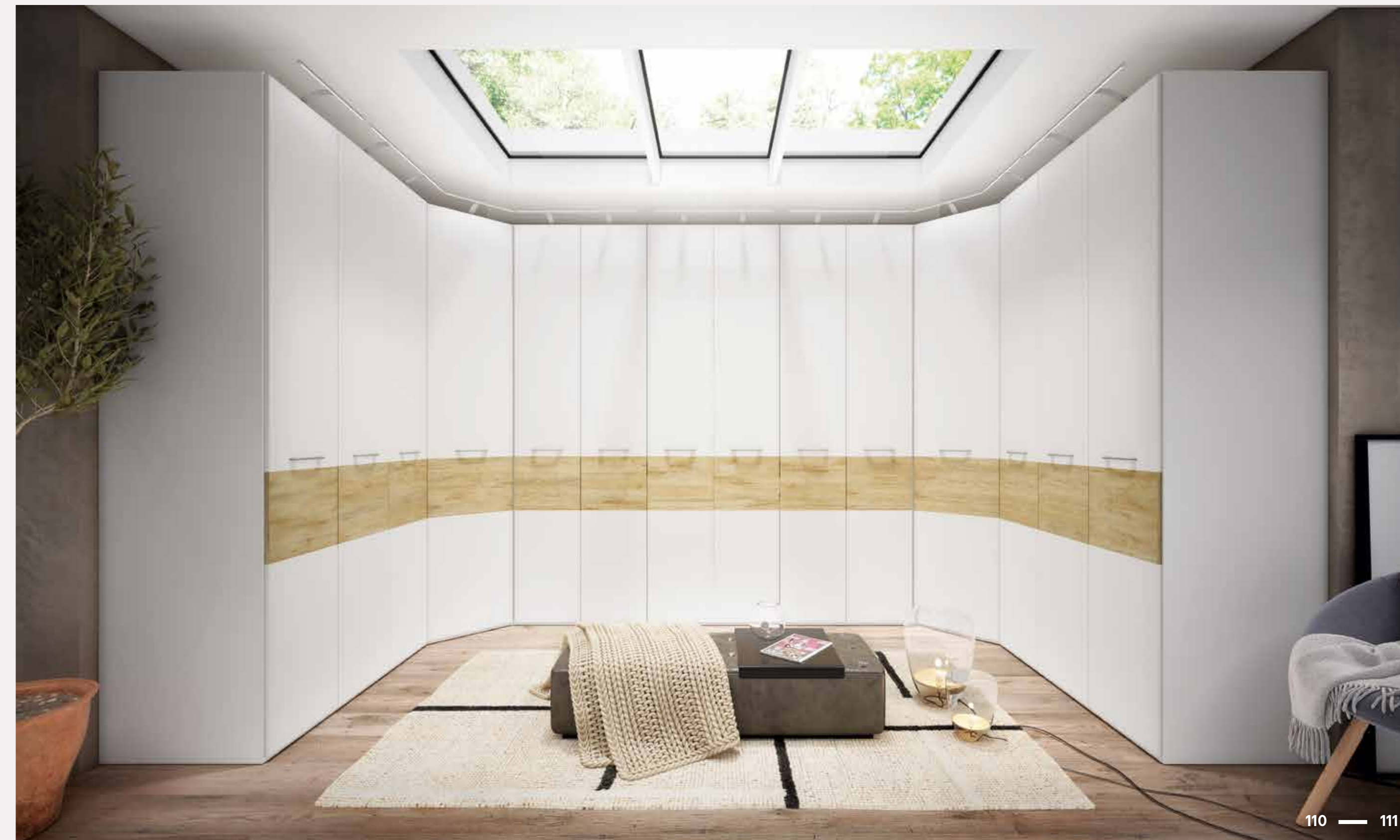
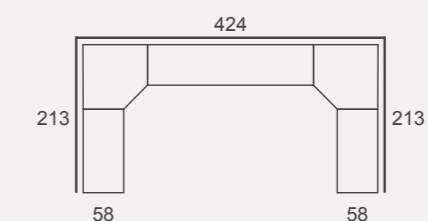



ARMARIO 06

NUDE

terminal zapatero con estantes -
armario de rincón puertas plegables tirador PLUS grafito -
armario 5P, + 5C. tirador PLUS y LES grafito

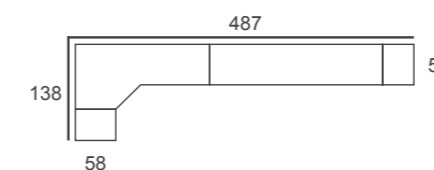

ACCESORIOS ARMARIOS OPCIONALES



Accesorio bandeja extraíble / Pull-out tray with frame / Plateau coulissant avec cadre



Accesorio bandeja extraíble con divisores para múltiples usos / Pull-out tray with dividers / Plateau coulissant avec séparateur



Accesorio pantalonero extraíble / Pull-out trouser hanger / Porte-pantalons coulissant



Accesorio estante extraíble con cesto / Wire basket with pull-out tray / Panier coulissant



Cajonera dos cajones / Chest of 2 drawers / Module intérieur 2 tiroirs



Cajonera tres cajones / Chest of 3 drawers / Module intérieur 3 tiroirs



Accesorio barra de colgar abatible / Pull-down hanger rail / Penderie rabattable



Accesorio estante extraíble / Pull-out tray / Plateau coulissant



Cajonera cuatro cajones / Chest of 4 drawers / Module intérieur 4 tiroirs



Accesorio pantalonero metálico extraíble / Metallic pull-out trouser hanger / Porte-pantalons coulissant métallique



Accesorio zapatero metálico extraíble / Metallic pull-out shoe rack / Range chaussures coulissant métallique

PUERTAS



Detalle puertas plegables / Detail of folding doors / Détail des portes pliantes



Detalle puertas correderas con cierre suave / Detail of sliding doors with soft closing / Détail des portes coulissantes avec fermeture softclose.



Detalle puertas batientes con cierre amortiguado. / Detail of swing doors with soft closing. / Détail des portes battantes avec fermeture amortie.

ILUMINACIÓN



Iluminación led opcional para exterior de armarios 35cm / Exterior optional led lighting for wardrobes 35cm / Illumination led optionnel pour extérieur d'armoire 35cm



Iluminación led opcional para exterior de armarios 70cm / Exterior optional led lighting for wardrobes 70cm / Illumination led optionnel pour extérieur d'armoire 70cm



Iluminación led opcional para entrepaños de dos puertas / Integrated optional led lighting / Illumination Led optionnel



Iluminación led opcional para entrepaños de una puerta, con sensor de movimiento que se acciona al abrir la puerta y se apaga al instante de haber cerrado la puerta.

Integrated optional wardrobe led lighting with motion sensor. The lights turn on as the door is opened, and they automatically switch off instantly after closing the door.

Illumination Led optionnel pour l'intérieur d'armoires avec capteur de mouvement. La lumière s'allume quand la porte s'ouvre et immédiatement s'éteint quand elle se ferme.



AUXILIAR N 01

AUXILIAR 01

NUDE
 armario 3P. tirador RAW grafito - regletas cierre -
 mesa escritorio - espejo cuadrado -
 módulo maletero -
 respaldo para módulo maletero

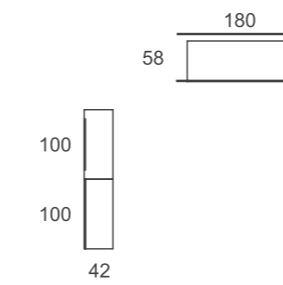

AUXILIAR 02

NATURALE
 mesa escritorio - espejo estantería

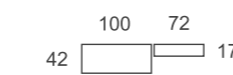

AUXILIAR N 02

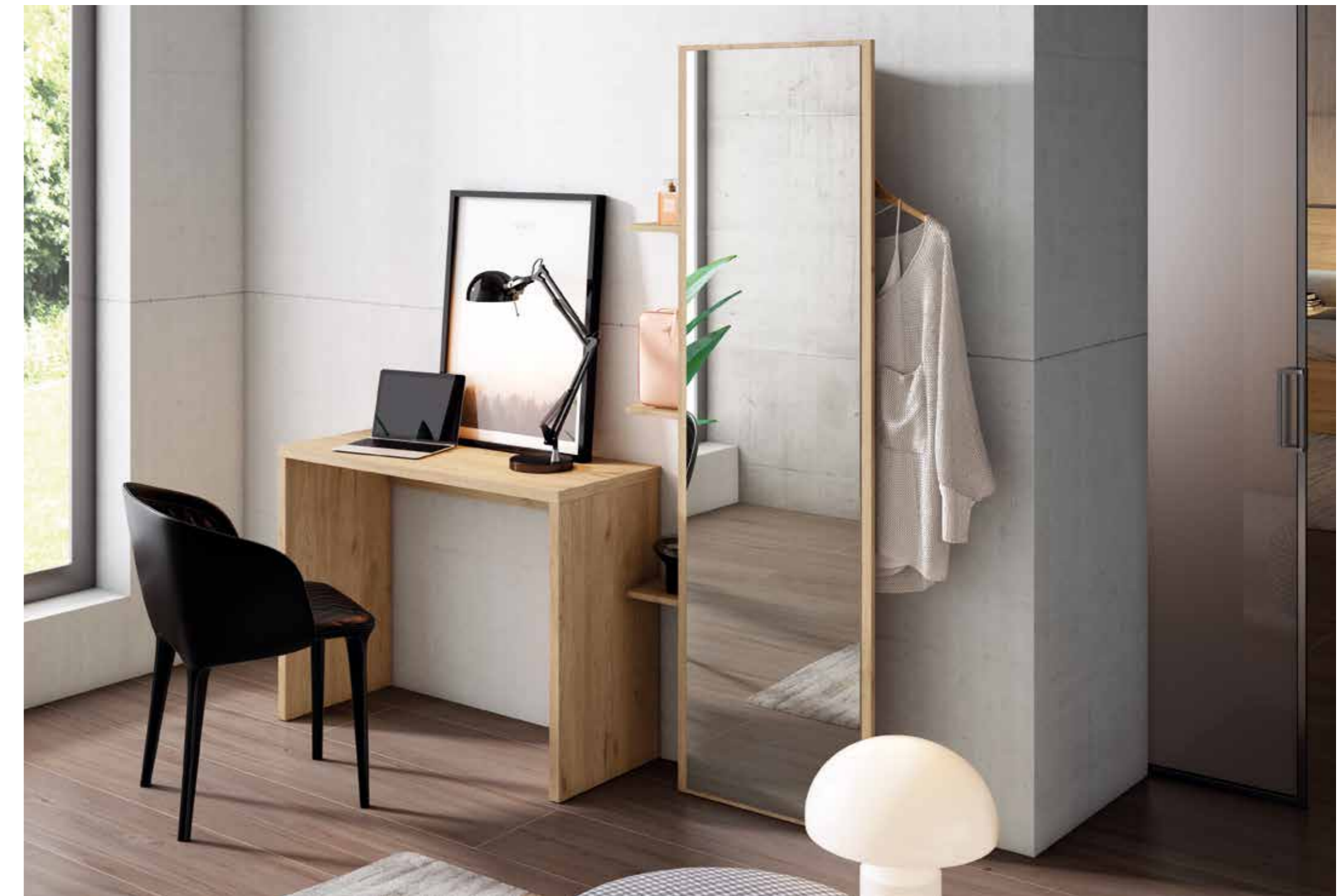

ZAPATEROS

Detalle del módulo zapatero
 Detail of the shoe rack unit.
 Détail de l'armoire à chaussures



28 CONFIGURACIONES DE CABECEROS

28 HEADBOARD CONFIGURATIONS / 28 CONFIGURATIONS DE TÊTE DE LIT



Regio



Garona



Enna



Hades



Nárthika



Aura



Gaia2



Nikaia



Hebros



Tesalia



Tarsus



Aura Red



Épiro



Épiro Liso



Épiro Tapizado



Kos



Kos Liso



Kos Tapizado



Axios



Quios



Hebe





Nuevo sistema de canapé elevable con doble posición para que tu día a día sea más sencillo.

(1) Detalle de la posición 1 de la apertura del canapé.

(2) Detalle de la posición 2 que permite un mejor acceso a la parte posterior del canapé y con la elevación horizontal de su base facilita hacer la cama.

New system of ottoman bed with double position to make your day to day easier.

(1) Detail of position 1 of the opening of the ottoman bed.

(2) Detail of position 2 for better access to the back of the ottoman bed and with the horizontal elevation of its base makes it easy to make the bed.

Nouveau système de lit coffre avec double position pour vous faciliter au jour le jour.

(1) Détail de la position 1 de l'ouverture du lit coffre.

(2) Détail de la position 2 qui permet un meilleur accès à l'arrière du lit coffre et l'élévation horizontale de sa base permet de faire facilement le lit.



6 MODELOS DE CANAPÉS Y BAÑERAS

6 MODELS OF OTTOMAN BEDS AND BED BASES / 6 MODÈLES DE LITS COFFRE ET CADRES DE LIT



CANAPÉ ELEVABLE 1C / OTTOMAN BED WITH 1 DRAWER / LIT COFFRE AVEC 1 TIROIR



CANAPÉ ELEVABLE 1P ABATIBLE / OTTOMAN BED WITH 1 FOLDING DOOR / LIT COFFRE AVEC 1 PORTE



CANAPÉ ELEVABLE RECTO 31 CM / OTTOMAN BED RECTO 31 CM / LIT COFFRE RECTO 31CM



CANAPÉ ELEVABLE FORMA 31 CM / OTTOMAN BED FORMA 31CM / LIT COFFRE FORMA 31CM



BAÑERA TIPO P / BED BASE TIPO "P" / CADRE DE LIT TIPO "P"



BAÑERA TIPO E / BED BASE TIPO "E" / CADRE DE LIT TIPO "E"

LOS CANAPÉS CUENTAN CON UN FONDO EN ACABADO EFECTO CUERO Y BASE TAPIZADA CON AIREADORES PARA EL COLCHÓN. LAS MEDIDAS DISPONIBLES SON DE 135 Y 150CM DE ANCHO POR 190 Y 200 CM DE LARGO. LAS BAÑERAS EN GROSORES DE 30 Y 50MM SE ENCUENTRAN DISPONIBLES EN 135, 150 Y 160 CM DE ANCHO POR 190 Y 200 CM DE LARGO.

THE OTTOMAN BEDS WITH A LEATHER EFFECT BOTTOM AND AN UNPOLSTERED BASE WITH MATTRESS AERATORS. AVAILABLE SIZES: 135 AND 150CM WIDE FOR 190 AND 200CM LONG. BED BASES IN THICKNESSES OF 30 AND 50MM ARE AVAILABLE IN 135, 150 AND 160 CM WIDE FOR 190 AND 200 CM LONG.

LIT COFFRE AVEC FOND EN EFFET CUIR ET PATEAU TAPISSÉ AVEC AÉRATEURS POUR MATELAS, CE QUI AUGMENTE L'ESPACE DE RANGEMENT DANS LA PIÈCE. LES MESURES DISPONIBLES SONT 135 ET 150 CM DE LARGE PAR 190 ET 200 CM DE LONG. LES CADRES DE LIT DANS LES ÉPAISSEURS DE 30 ET 50 MM SONT DISPONIBLES EN 135, 150 ET 160 CM DE LARGE PAR 190 ET 200 CM DE LONG.

SERIE INO



SERIE KAP NEW



SERIE INO TIRADOR



SERIE LUX



SERIE TOP





detalle mesita LUX
Detail of the LUX bedside
Détail de la table de nuit LUX



Detalle de la mesita KAP
Detail of the KAP bedside
Détail de la table de nuit KAP



Detalle de la mesita TOP
Detail of the TOP bedside
Détail de la table de nuit TOP



Detalle de la mesita INO
Detail of the INO bedside
Détail de la table de nuit INO

MESITAS



PATA DIAMANTE BLANCA



PATA RECTA PLATEADA



PATA NÓRDICA BLANCA



PATA HOME GRAFITO



BASE BLANCO NORDIC

TOP



PATA DIAMANTE NEGRA



PATA RECTA PLATEADA



PATA NÓRDICA BLANCA



PATA HOME GRAFITO



BASE BLANCO NORDIC

INO



PATA DIAMANTE PLATEADA



PATA RECTA PLATEADA



PATA NÓRDICA GRIS TORMENTA



PATA HOME GRAFITO



PATA HOME GRAFITO SIN BASE

LUX



PATA DIAMANTE BLANCA



PATA RECTA PLATEADA



PATA NÓRDICA BLANCA



PATA HOME GRAFITO



BASE BLANCO NORDIC

KAP

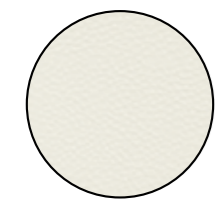

INTERIOR
EFECTO CUERO
Inside in leather effect
Intérieur effet cuir



ÍNDICE



01 AXIOS / págs 02 - 03



02 AXIOS / págs 04 - 05



03 AXIOS / págs 06 - 07



04 TESALIA / págs 08 - 09



05 TESALIA / págs 10 - 11



26 REGIO / págs 58 - 59



27 REGIO / págs 60 - 63



28 NIKAIKA / págs 64 - 65



29 NIKAIKA / págs 66 - 67



30 QUIOS / págs 70 - 71



06 TARSUS / págs 14 - 15



07 TARSUS / págs 16 - 17



08 TARSUS / págs 18 - 19



09 ENNA / págs 20 - 21



10 ENNA / págs 22 - 23



31 QUIOS / págs 72 - 73



32 HEBE / págs 74 - 75



33 HEBE / pág 76



34 HEBE / pág 77



35 HEBE / págs 78 - 79



11 ENNA / págs 24 - 25



12 KOS / págs 28 - 29



13 KOS / págs 30 - 33



14 ÉPIRO / págs 34 - 35



15 ÉPIRO TAPIZADO / pág 36



36 HADES / págs 80 - 81



37 HADES / págs 84 - 85



38 AURA RED / págs 86 - 87



39 AURA / págs 88 - 89



40 HEBROS / págs 90 - 93



16 ÉPIRO LISO / pág 37



17 NÁRTHIKA / págs 38 - 41



18 NÁRTHIKA / págs 42 - 43



19 GAI2 / págs 44 - 45



20 GAI2 / págs 46 - 47



41 ABATIBLE V / págs 96 - 97



42 ABATIBLE H / págs 98 - 99



ARMARIO 01 / págs 104 - 105



ARMARIO 02 / pág 106



ARMARIO 03 / pág 107



21 GAI2 / págs 48 - 49



22 GARONA / págs 52 - 53



23 GARONA / pág 54



24 GARONA / pág 55



25 GARONA / págs 56 - 57



ARMARIO 04 / págs 108 - 109



ARMARIO 05 / págs 110 - 111



ARMARIO 06 / págs 112 - 113



AUXILIAR 01 / pág 116



AUXILIAR 02 / pág 117

COLORES BASE

BASE COLOURS / COULEURS BASE

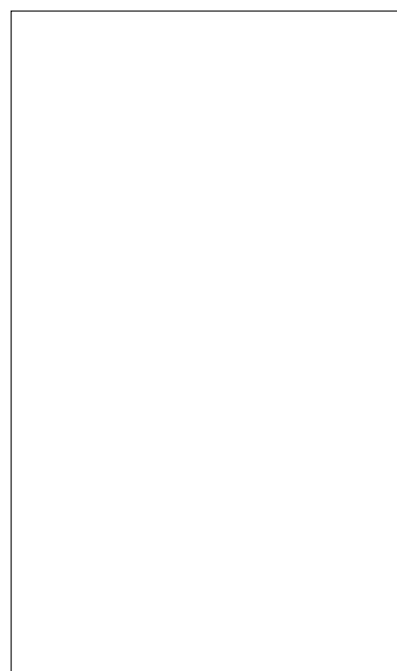

BLANCO MATE



BLANCO NORDIC



SHAMAL



IRON



NUDE



NATURALE



NOCETO

TIRADORES

HANDLES / POIGNÉES



LESS GRAFITO



LESS PLATEADO



RAW L GRAFITO



LUNA ALUMINIO



PLUS GRAFITO



PLUS PLATEADO



RAW GRAFITO

TAPIZADOS VELVET

UPHOLSTERY VELVET / REVÊTEMENTS VELVET



ÓNIX

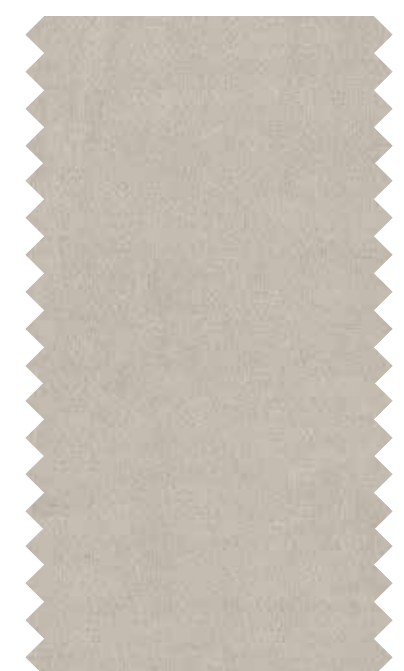

PETRA



ÁGATA

COLORES COMBINACIÓN

COMBINATION COLOURS / COULEURS COMBINAISON



BORA



VISIÓN CHIC

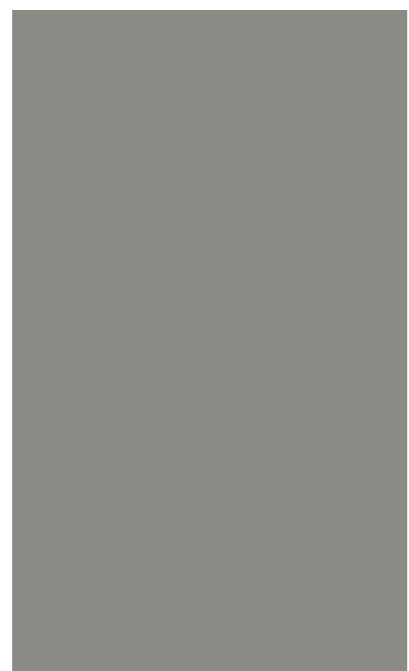

GRIS TORMENTA



STONE ROCK



BOCAMINA



www.exojo.com - comercial@exojo.com

Diseño y desarrollo de producto:
Grupo Exojo

Grupo Exojo, se reserva el derecho de introducir modificaciones, cambio de detalles, etc. que considere necesarios en beneficio del producto y del cliente.

Debido a los procesos de impresión los colores que aparecen en este catálogo deben considerarse aproximados, no exactos.

Queda prohibido cualquier tipo de reproducción total o parcial de las imágenes, textos, ilustraciones y grafismos que aparecen en este catálogo.

Copyright 2019

**СРЕТА
TOP^{V.5}**